



भारतीय उष्णदेशीय मौसम विज्ञान संस्थान

(पृथ्वी विज्ञान मंत्रालय, भारत सरकार का एक स्वायत्त संस्थान)

डॉ. होमी भाभा मार्ग पाषाण, पुणे- ४११ ००८

INDIAN INSTITUTE OF TROPICAL METEOROLOGY

(An Autonomous Institute of the Ministry of Earth Sciences, Govt. of India)

Dr. Homi Bhabha Road, Pashan, Pune - 411 008, India



पीएस/PS/132/01/2017/

13 फरवरी, 2018

सेवा में/To,

विषय : मोडुलर फर्नीचर खरीद के संदर्भ (आपूर्ति तथा अधिष्ठापन)।

Sub : Supply & installation of "Modular Furniture".

प्रिय महोदय / Dear Sir,

यह संस्थान उपर्युक्त विषयानुसार सामग्री की खरीद करना चाहता है। इसलिए, इच्छुक बोलीदाताओं से अनुरोध है कि अपनी तकनीकी तथा कीमत बोली निम्नलिखित निर्देशानुसार प्रस्तुत करें :

This Institute wishes to procure goods as per subject cited above. Therefore, interested bidders are requested to submit their Technical and Price bids as per the instructions given below :-

बोली प्रस्तुत करने की अंतिम तिथि 28 फरवरी 2018 को 1500 बजे तक है।

The last date of submission of bids is **28th February, 2018 up to 1500 hrs.**

तकनीकी बोली उसी दिन 1530 बजे ऑनलाइन पद्धति द्वारा खोली जाएगी।

Technical Bids will be opened on the same day at **1530 hrs.** by online mode only.

आपूर्ति की संभाव्यता, कार्य, तकनीकी विशिष्टीकरण, विनियम एवं शर्तों की विस्तृत जानकारी के लिए <http://www.mstcecommerce.com/eprichome/iitm> पर उपलब्ध निविदा सं. पीएस/132/01/2017 का संदर्भ लें। संभावित बोलीदाताओं की व्यापक जानकारी एवं सूचना हेतु निविदा दस्तावेज इस संस्थान की वेबसाइट <http://www.tropmet.res.in/tenders> के साथ <https://eprocure.gov.in/cppp> पर भी उपलब्ध हैं।

For more details of requirement, scope of the supply / work, technical specification, terms & condition; may please refer Tender No. PS/132/01/2017 available on <http://www.mstcecommerce.com/eprichome/iitm>. Tender document are also available on this Institute's website <http://www.tropmet.res.in/tenders> as well as <https://eprocure.gov.in/cppp> for wide publicity and information of the prospective bidders.

बोलीदाता जो उपर्युक्त निविदा में भाग लेना चाहते हैं, उन्हें वेब पोर्टल <http://www.mstcecommerce.com/eprichome/iitm> पर उपलब्ध सूचना के अनुसार पंजीकृत करना होगा।

Bidders willing to participate for the above tender, has to get registered themselves on web portal <http://www.mstcecommerce.com/eprichome/iitm> as per the instruction available at there.

धन्यवाद/Thanking you,

भवदीय/Yours faithfully,

(यो. श. बेलगुडे / Y. S. Belgude)

सहायक प्रबंधक / Assistant Manager

कृते निदेशक / for Director

ईमेल/E-mail : psu.iitm@tropmet.res.in

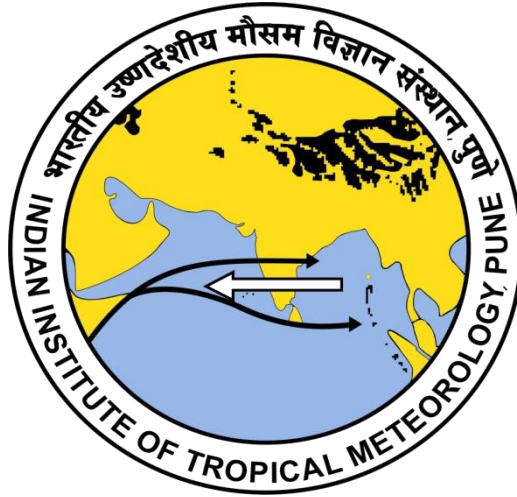

TENDER DOCUMENT

FOR

**Supply & Installation of Modular Furniture as per enclosed
Technical Details & Specifications for IITM, Pune.**

**INDIAN INSTITUTE OF TROPICAL METEOROLOGY
(AN AUTONOMOUS INSTITUTE OF MINISTRY OF EARTH
SCIENCES, GOVERNMENT OF INDIA)
DR. HOMI BHABHA ROAD, PASHAN, PUNE 411 008
MAHARASHTRA, INDIA**

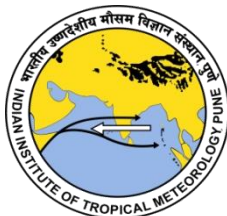

INDIAN INSTITUTE OF TROPICAL METEOROLOGY
 (AN AUTONOMOUS INSTITUTE OF MINISTRY OF EARTH SCIENCES, GOVERNMENT OF INDIA)
 DR. HOMI BHABHA ROAD, PASHAN, PUNE 411 008 MAHARASHTRA, INDIA
 Tel #: 00 91 20 2590 4200
 Fax #: 00 91 20 2586-5142
 Email: psu.iitm@tropmet.res.in
 Website: www.tropmet.res.in

Invitation for Bids through E-procurement

Date: 13/02/2018

The Indian Institute of Tropical Meteorology (IITM), Pune an autonomous body under Ministry of Earth Sciences (MoES), Govt. of India. IITM is country's premiere research Institute to generate scientific knowledge in the field of meteorology and atmospheric sciences that has potential application in various fields such as agriculture, economics, health, water resources, transportation, communications, etc. It functions as a national centre for basic and applied research in monsoon meteorology. The Director, IITM would like to procure the following Goods / Services for its day-to-day research. The Technical specifications, Allied requirements and Scope of Supply are given in **Chapter 4** appended herewith.

Sr. No.	Tender No.	Brief Description of Goods / Services	Quantity	Single / Two Bid
1	PS/132/01/2017	Supply & Installation of Modular Furniture as per enclosed Technical Details & Specifications.	As per list enclosed	Two

- The bid has to be submitted online on Institute's e-procurement system hosted at website <http://www.mstcecommerce.com/eprochome/iitm> as per the process mentioned on the same website. Bidder has to register on the above website & to pay the transaction fee directly to MSTC Limited to participate in the bidding process through e-procurement. Bidders are advised to follow the instructions provided in 'Vendor's Guide' available on the said e-procurement website. Bidders can contact at **022-2286 6261** for any technical queries regarding registration and submission of bid on the above portal.

- The address for submission of technical bids only and for obtaining further information:

Purchase and Stores Officer
 Indian Institute of Tropical Meteorology,
 Dr.Homi Bhabha Road, Pashan,
 Pune - 411008 (India)

- A Pre-bid Conference will be held on schedule mentioned below. All prospective bidders are requested to kindly submit their queries to the address indicated above so as to reach the Stores & Purchase Officer at least one day before Pre-Bid Conference.

	Date	Time in hours (IST)	Venue
Pre-Bid Conference	21st February, 2018	1130 hrs.	IITM, Pune.

- The Bid prepared by the Bidder shall include the following:-

i)	Bid Security a) In case of Foreign Bidder : USD 784.00 b) In case of Indigenous Bidder : ₹52,500/-
ii)	Forms as specified in Chapter No.8

- All bids must be accompanied by a Bid Security as specified above and must be delivered to the above office before the date and time indicated below. In the event of the date specified for bid receipt is declared as a closed holiday, the due date for submission of bids will be the following working day at the appointed time.

- The Schedule for Submission of Bids is as follows:-

	Date	Time in hours (IST)	Submit to / Venue
Submission of Bids	28th February, 2018	Upto 1500 hrs.	As detailed at Sr. No.1
Opening of Bids	28th February, 2018	1530 hrs	

- The Director, **The Indian Institute of Tropical Meteorology (IITM), Pune** reserves the right to accept or reject any or all tenders / offers either in part or in full or to split the order without assigning any reasons there for. NIT has also been published on Government's Central Procurement Portal (CPP) <http://www.eprocure.gov.in> as well as this Institute's Website: <http://www.tropmet.res.in> which may also be referred for more details.

CONTENTS OF TENDER / BIDDING DOCUMENT

The bidding documents, apart from the Invitation for Bids / Notice Inviting Tender have been divided into Eight Chapters as under:

Chapter No.	Name of the Chapter	Page No.
1	Instructions to Bidder (ITB)	5
2A	General Conditions of Contract (GCC)	18
2B	Special Conditions of Contract (SCC)	31
3	Schedule of Requirements	33
4	Specifications, Allied Technical Details And Scope of Supply	34
5	Qualification requirements	37
6	Price Schedule Forms	40
7	Contract Form	43
8	Standard Forms	44

LIST OF SHORT FORMS AND FULL FORMS

SHORT FORM	FULL FORM
BG	BANK GUARANTEE
BS	BID SECURITY
CIF	COST INSURANCE & FREIGHT
CIP	CARRIAGE PAID TO
IITM	INDIAN INSTITUTE OF TROPICAL METEOROLOGY,
CVC	CENTRAL VIGILANCE COMMISSION
DGS&D	DIRECTOR GENERAL OF SUPPLIES & DISPOSAL
EMD	EARNEST MONEY DEPOSIT
ESIC	EMPLOYEES STATE INSURANCE CORPORATION
FCA	FREE CARRIER
FOB	FREE ON BOARD
GCC	GENERAL CONDITIONS OF CONTRACT
GOI	GOVERNMENT OF INDIA
ICC	INTERNATIONAL CHAMBERS OF COMMERCE
IEMs	INDEPENDENT EXTERNAL MONITORS
IP	INTEGRITY PACT
IPC	INDIAN PENAL CODE
IST	INDIAN STANDARD TIME
IT	INCOME TAX
ITB	INSTRUCTIONS TO BIDDERS
JS (A)	JOINT SECRETARY (ADMINISTRATION)
LC	LETTER OF CREDIT
LD	LIQUIDATED DAMAGES
MAF	MANUFACTURER AUTHORISATION FORM
NIT	NOTICE INVITING TENDER
NSIC	NATIONAL SMALL INDUSTRIES CORPORATION
PS	PERFORMANCE SECURITY
SCC	SPECIAL CONDITIONS OF CONTRACT
UNCITRAL	UNITED NATIONS COMMISSION ON INTERNATIONAL TRADE LAW

CHAPTER 1 -INSTRUCTIONS TO BIDDERS - TABLE OF CONTENTS

Clause No.	Contents	Page No.
A. Introduction		5
1.1	Eligible Bidders	5
1.2	Cost of Bidding	5
1.3	Fraud and Corruption	5
B. The Bidding Documents		5
1.4	Cost of Bidding Documents	5
1.5	Content of Bidding Documents	5
1.6	Clarification of Bidding Documents	6
1.7	Amendment to Bidding Documents	6
C. Preparation of Bids		6
1.8	Language of Bid	6
1.9	Documents Comprising the Bid	7
1.10	Bid form and Price Schedule	7
1.11	Bid Prices	7
1.12	Bid Currencies	8
1.13	Documents establishing Bidder's Eligibility and Qualifications	8
1.14	Documents establishing Goods' Eligibility and Conformity to Bidding Documents	8
1.15	Bid Security / Earnest Money Deposit	9
1.16	Period of Validity of Bids	10
1.17	Format and Signing of Bid	10
D. Submission and Sealing of Bids		11
1.18	Submission, Sealing and Marking of Bids	11
1.19	Due date for Submission of Bids	12
1.20	Submission of Bids	12
1.21	Withdrawal, Substitution and Modification of Bids	12
E. Opening and Evaluation of Bids		13
1.22	Opening of Bids by the Purchaser	13
1.23	Confidentiality	13
1.24	Clarification of Bids	13
1.25	Preliminary Examination	13
1.26	Responsiveness of Bids	13
1.27	Non-Conformity, Error and Omission	14
1.28	Examination of Terms & Conditions, Technical Evaluation	14
1.29	Conversion of Single Currency	14
1.30	Evaluation and Comparison of Bids	15
1.31	Comparison of Bids	15
1.32	Contacting the Purchaser	15
1.33	Post qualification	16
F. Award of Contract		16
1.34	Negotiations	16
1.35	Award Criteria	16
1.36	Purchaser's right to vary Quantities at the Time of Award or later	16
1.37	Purchaser's right to accept any Bid and to reject any or all Bids	16
1.38	Notification of Award	16
1.39	Signing of Contract	16
1.40	Order Acceptance	16
1.41	Performance Security	17

A. Introduction

Instructions to bidder are broad guidelines to be followed while formulating the bid and its submission to the Purchaser. It also describes the methodology for opening and evaluation of bids and consequent award of contract.

1.1 Eligible Bidders

- 1.1.1. This Invitation for Bids is open to all suppliers.
- 1.1.2. Bidders should not be associated, or have been associated in the past, directly or indirectly, with a firm or any of its affiliates which have been engaged by the Purchaser to provide consulting services for the preparation of the design, specifications, and other documents to be used for the procurement of the goods to be purchased under this Invitation of Bids.
- 1.1.3. Bidders who fulfil the Eligibility Criteria mentioned in **Chapter 5** will be considered for Technical Evaluation of bids.

1.2 Cost of Bidding

The Bidder shall bear all costs associated with the preparation and submission of its bid, and "the Purchaser", will in no case be responsible or liable for these costs, regardless of the conduct or outcome of the bidding process.

1.3 Fraud and corruption

- 1.3.1. The purchaser requires that the bidders, suppliers and contractors observe the highest standard of ethics during the procurement and execution of such contracts. In pursuit of this policy, the following are defined:

Sr. No.	Term	Meaning
(a)	Corrupt practice	The offering, giving, receiving, or soliciting, directly or indirectly, of anything of value to influence the action of a public official in the procurement process or in contract execution.
(b)	Fraudulent practice	a misrepresentation or omission of facts in order to influence a procurement process or the execution of a contract.
(c)	Collusive practice	means a scheme or arrangement between two or more bidders, with or without the knowledge of the purchaser, designed to establish bid prices at artificial, non-competitive levels.
(d)	Coercive practice	means harming or threatening to harm, directly or indirectly, persons or their property to influence their participation in the procurement process or affect the execution of a contract.

- 1.3.2. The Purchaser will reject a proposal for award if it determines that the Bidder recommended for award has, directly or through an agent, engaged in corrupt, fraudulent, collusive or coercive practices in competing for the Contract in question.

B. The Bidding Documents

1.4 Cost of Bidding Documents

The bidding documents are to be downloaded from Institute's e-procurement website hosted at <http://www.mstcecommerce.com/eprochome/iltm> as per the procedure mentioned on the said website. The bidding document is free of cost however transaction fees mentioned on the website has to be paid according to the procedure mentioned at the website.

1.5 Content of Bidding Documents

- 1.5.1. The Goods / Services required, bidding procedures and contract terms are prescribed in the bidding documents which should be read in conjunction. The bidding documents, apart from the Invitation for Bids / Notice Inviting Tender have been divided into Eight Chapters.
- 1.5.2. The Bidder is expected to examine all instructions, forms, terms, and specifications in the bidding documents. Failure to furnish all information required by the bidding documents or submission of a bid not substantially responsive to the bidding documents in every respect will be at the Bidder's risk and may result in rejection of its bid.

1.6 Clarification of bidding documents

1.6.1. In case when there is NO PRE-BID CONFERENCE

A prospective Bidder requiring any clarification of the Bidding Documents shall contact the Purchaser in writing at the Purchaser's address specified in the Special Conditions of Contract (SCC). The Purchaser will respond in writing to any request for clarification, provided that such request is received not later than ten (10) days prior to the due date for submission of bids. The Purchaser shall host the response on its website, including a description of the inquiry but without identifying its source. Should the Purchaser deem it necessary to amend the Bidding Documents as a result of a clarification, it shall do so following the procedure under *Clause 1.7* relating to amendment of bidding documents and *Clause 1.19* relating to Due date for Submission of Bids. The clarifications and amendments issued would also be hosted on the website of the purchaser for the benefit of the prospective bidders who are expected to take cognizance of the same before formulating and submitting their bids.

1.6.2. In case when there is PRE-BID CONFERENCE

- a) A prospective Bidder requiring any clarification of the Biding Documents shall contact the Purchaser in writing at the Purchaser's address specified in the Special Conditions of Contract (SCC), latest by the date specified in the Invitation for Bids / NIT which would be deliberated as per **Clause 1.6.2 (b)** of Instructions to the Bidders. No request for clarification or query shall be normally entertained after the **Pre-Bid Conference**. Should the Purchaser deem it necessary to amend the Bidding Documents as a result of a clarification, it shall do so following the procedure under *Clause 1.7* relating to amendment of Bidding Documents and *Clause 1.19* relating to Due Date for Submission of Bids. The clarifications and amendments issued would also be hosted on the website of the Purchaser for the benefit of the other prospective bidders.
- b) A Pre-bid Conference shall be held as indicated in Invitation to Bid. All prospective bidders are requested to kindly attend the Pre-bid Conference. In order to facilitate IITM for proper conduct of the Pre-bid Conference, all prospective bidders are requested to kindly submit their queries (with envelope bearing Tender No. and Date on top and marked "Queries for Pre-bid Conference") so as to reach IITM as indicated in Invitation to Bid. IITM shall answer the queries during the pre-bid conference, which would become a part of the proceedings of the Pre-bid Conference. These proceedings will become a part of clarifications / amendments to the bidding documents and would become binding on all the prospective bidders. These proceedings would also be hosted on IITM website www.tropmet.res.in for the benefit of all the prospective bidders. Before formulating and submitting their bids, all prospective bidders are advised to surf through the IITM website after the Pre-bid Conference, in order to enable them take cognizance of the changes made in the bidding document.

1.7 Amendment to Bidding Documents

- 1.7.1. At any time prior to the due date for submission of bids, the Purchaser may, for any reason, whether at its own initiative or in response to a clarification requested by a prospective bidder, modify the bidding documents by amendment.
- 1.7.2. All prospective bidders who have downloaded the Tender Document should surf Institute's e-procurement website <http://www.mstcecommerce.com/eprochome/iitm/> from time to time to know about the changes / modifications in the Tender Document. All prospective bidders are expected to surf the website before formulating and submitting their bids to take cognizance of the amendments.
- 1.7.3. In order to allow prospective bidders reasonable time to take the amendment into account while formulating their bids, the Purchaser, at its discretion, may extend the due date for the submission of bids and host the changes on the website of the purchaser.

C. Preparation of bids

1.8 Language of Bid

- 1.8.1. The bid prepared by the Bidder, as well as all correspondence and documents relating to the bid exchanged by the Bidder and the Purchaser, shall be written in English language only especially when the details are technical. However, if GOI makes it mandatory under Rajbhasha Abhiyan, in that case views of Rajbhasha unit of IITM may be sought.

- 1.8.2. The Supplier shall bear all costs of translation, if any, to the English language and bear all risks of the accuracy of such translation, for documents provided by the Supplier.

1.9 Documents Comprising the Bid

The bid prepared by the Bidder shall include the following as per the requirement of the Tender Document:

a	Bid Security as specified in the Invitation to Bids
b	Bidder Information Form
c	Manufacturer's Authorization Form
d	Documents required to fulfil Eligibility and Qualification criteria as specified in Chapter-5
e	Detailed Technical Specifications and Scope of Supply
f	Schedule of requirements
g	Performance Statement Form
h	Service support details form
i	Deviation Statement Form
j	Bid form
k	Price Schedule Form(s)
l	Documentary evidence establishing that the bidder is eligible to bid and is qualified to perform the contract if its bid is accepted
m	Documents establishing goods eligibility and conformity to bidding documents
n	DGS&D Registration certificate in case the items under procurement falls under the restricted category of the current export-import policy of the Government of India

The documents comprising bid should be submitted in the **above sequence in orderly manner**.

1.10 Bid form and Price Schedule

The bidder shall complete the Bid Form and the appropriate Price Schedule form as given in Chapter- 6 furnished in the bidding documents. These forms must be completed without any alterations to its format and no substitutes shall be accepted. All blank spaces shall be filled in with the information requested. The Bid Form and the appropriate Price Schedule form shall be submitted in accordance with **ITB Clause 1.18.3** of the bidding documents.

1.11 Bid Prices

- 1.11.1. The Bidder shall indicate on the appropriate price schedule form, the unit prices and total bid prices of the Goods / Services it proposes to supply / to provide (render) under the contract.

- 1.11.2. Prices indicated on the price-schedule form shall be entered separately in the following manner:

(a) **For Goods manufactured within India:**

i)	The price of the goods quoted Ex-works including taxes already paid.
ii)	GST and other taxes like LBT / Octroi etc. which will be payable on the goods if the contract is awarded.
iii)	The charges for inland transportation, insurance and other local services required for delivering the goods at the desired destination as specified in the price schedule form.
iv)	The installation, commissioning and training charges including any incidental services, if any.

(b) **For Goods manufactured abroad:**

i)	The price of the goods, quoted on FCA (named Airport abroad) or FOB (named port of shipment), as specified in the price schedule form.
ii)	The charges for insurance and transportation of the goods to the port / place of destination.
iii)	The agency commission charges payable to Indian agent in Indian rupees, if any.
iv)	The installation, commissioning and training charges including any incidental services, if any

- 1.11.3. The terms FOB, FCA, CIF, CIP etc shall be governed by the rules prescribed in the current edition of the Incoterms published by the International Chambers of Commerce, Paris.

- 1.11.4. Where there is no mention of packing, forwarding, freight, insurance charges, taxes etc. such offer shall be rejected as incomplete.
- 1.11.5. The price quoted shall remain fixed during the contract period and shall not vary on any account.
- 1.11.6. All lots and items must be listed and priced separately in the Price Schedules. If a Price Schedule shows items listed but not priced, their prices shall be assumed to be included in the prices of other items. Lots or items not listed in the Price Schedule shall be assumed to be not included in the bid.
- 1.11.7. The purchases made by the purchaser for scientific purpose are exempt from Custom Duty is charged at a concessional rate, as follows:-

Custom Duty	The Purchaser is exempted from payment of Custom Duty vide Govt. Of India Notification No.51/96-Customs dated 23 rd July, 1996
--------------------	--

- 1.11.8. In case of imports the freight & insurance will be paid by the Purchaser, as the consignments are to be shipped through the Purchaser nominated freight forwarder **unless otherwise mentioned specifically**.
- 1.11.9. The quotation should be only in Indian Rupees for indigenous items. In case of foreign quote, the vendors may quote their rates in Indian Rupees as well as in Foreign Currency.
- 1.11.10. In case of INR bids the price criteria should be on Free Delivery to IITM, Pune. Govt. Levies like GST, LBT / Octroi etc., if any, shall be paid at actual rates applicable on the date of delivery. Rates should be quoted accordingly giving the basic price, GST etc., if any. IITM is exempted from paying Local Body Tax (LBT) & hence supplier supplying items from outside Pune Municipal limits should quote excluding LBT.
- 1.11.11. Custom Duty is levied on all import meant for IITM. Hence, the suppliers are requested to quote only on FOB/FCA basis, freight, insurance and custom duty as applicable to R&D Institutions will be paid by the Purchaser.

Note: All payments due under the contract shall be paid after deduction of statutory levies at source (like ESIC, IT (TDS), GST, LBT / Octroi etc.), wherever applicable.

1.12 Bid Currencies

Prices shall be quoted in Indian Rupees for offers received for supply within India and in freely Convertible foreign currency in case of offers received for supply from foreign countries.

1.13 Documents Establishing Bidder's Eligibility and qualifications

- 1.13.1. The bidder shall furnish, as part of its bid, documents establishing the bidders' eligibility to bid and its qualification to perform the contract if its bid is accepted.
- 1.13.2. The documentary evidence of the bidders qualification to perform the contract if the bid is accepted shall establish to the purchasers satisfaction that:

(a)	The bidder meets the qualification criteria listed in bidding documents, if any.
(b)	Bidder who doesn't manufacture the goods it offers to supply shall submit Manufacturers' Authorization Form using the form specified in the bidding document to demonstrate that it has been duly authorized by the manufacturer of the goods to quote and / or supply the goods.
(c)	In case a bidder not doing business within India, it shall furnish the certificate to the effect that the bidder is or will be represented by an agent in India, equipped and able to carry out the supply, maintenance, repair obligations etc. during the warranty and post warranty period or ensure a mechanism at place for carrying out the supply, maintenance, repair obligations etc. during the warranty and post-warranty period.

- 1.13.3. Conditional tenders / offers shall **not** be accepted.

1.14 Documents Establishing Goods' Eligibility and Conformity to Bidding Documents

- 1.14.1. To establish the goods' eligibility, the documentary evidence of the goods and services eligibility shall consist of a statement on the country of origin of the goods and services offered which shall be confirmed by a certificate of origin at the time of shipment.
- 1.14.2. To establish the conformity of the goods and services to the specifications and schedule of requirements of the bidding document, the documentary evidence of conformity of the goods and

services to the bidding documents may be in the form of literature, drawings and data, and shall consist of :

(a)	A detailed description of the essential technical and performance characteristics of the goods;
(b)	A list giving full particulars, including available sources and current prices, of spare parts, special tools, etc., necessary for the proper and continuing functioning of the goods during the warranty period following commencement of the use of the goods by the Purchaser in the Price- bid ; and
(c)	An item-by-item commentary on the Purchaser's Technical Specifications demonstrating substantial responsiveness of the goods and services to those specifications or a statement of deviations and exceptions to the provisions of the Technical Specifications.

1.14.3. For purposes of the commentary to be furnished pursuant to above, the Bidder shall note that standards for workmanship, material and equipment, designated by the Purchaser in its Technical Specifications are intended to be descriptive only and not restrictive. The Bidder may substitute these in its bid, provided that it demonstrates to the Purchaser's satisfaction that the substitutions ensure substantial equivalence to those designated in the Technical Specifications.

1.15 Bid Security (BS) / Earnest Money Deposit (EMD)

1.15.1. The Bidder shall furnish, as part of its bid, a Bid security (BS) / Earnest Money Deposit (EMD) of amount as specified in NIT in the form of a Bank Guarantee / Demand Draft drawn on any Scheduled / Commercial / Nationalized Bank in favour of the Director, **The Indian Institute of Tropical Meteorology (IITM), Pune**, The scan copy of the Bid Security / Earnest Money Deposit (EMD) has to be uploaded in the e-procurement website of the Institute and Original copy of the same has to be kept in the Technical Bid envelop which needs to be submitted on or before date submission of bids. Alternately EMD amount can be deposited in IITM, Pune account by RTGS/NEFT/SWIFT. The details of online transfer may be communicated to IITM Pune immediately.

A. In case of Foreign Bidder(s):

- a) The BS shall be submitted either by the principal or by the Indian agent.
- b) The bidder who submits the tender on behalf of their principals should produce documentary evidence in support of their authority to quote.
- c) The Bank Guarantee is insisted due to steep fluctuations in foreign exchange hence the foreign DDs are not accepted towards BS/EMD

B. In the case of indigenous bidders:

- a) The BS shall be submitted by the manufacturer or their specifically authorized dealer/bidder.

1.15.2. Bids submitted without BS/EMD will stand rejected. BS/EMD will not be accepted in the form of cash / cheque or any other form other than DD/Banker's Cheque/TDR/Bank Guarantee as per Chapter-8: **Annexure A**. No interest is payable on BS/EMD

1.15.3. The bid security is required to protect the Purchaser against the risk of Bidder's conduct, which would warrant the Bid security's forfeiture.

1.15.4. The bid security shall be in Indian Rupees for offers received for supply within India and denominated in the currency of the bid or in any freely convertible foreign exchange in the case of offers received for supplies from foreign countries in equivalent Indian Rupees. The bid security shall be in one of the following forms at the bidders' option:

(a)	A Bank Guarantee (BG) issued by a Nationalized / Scheduled bank / Commercial / Foreign Bank operating in India in the form provided in the bidding documents and valid for 45 days beyond the validity of the bid. In case a bidder desires to submit a BG issued from a foreign bank, then the same should be confirmed by a Nationalised / Scheduled Indian bank;
OR	
(b)	A Banker's cheque or demand draft in favour of the Purchaser issued by any Nationalised / Scheduled Indian bank / Commercial bank.
OR	
(c)	EMD amount can be deposited in IITM, Pune account by RTGS/NEFT/SWIFT. Account No. : 11099449733

Bank Name and address : STATE BANK OF INDIA
IFSC Code : SBIN0000454
Swift Code : SBININBB238

- 1.15.5. The bid security shall be payable promptly upon written demand by the purchaser in case the conditions listed in the **ITB clause 1.15.11** are invoked.
- 1.15.6. The bid security should be submitted in its original form. Copies shall not be accepted.
- 1.15.7. Bid security / EMD is mandatory requirement and exemption is applicable to the firms registered with NSIC only for the manufacture of the tendered goods and not for selling products manufactured by other companies.
- 1.15.8. The Bid Security of unsuccessful bidder will be discharged / returned as promptly as possible but positively within a period of 30 days after the expiration of the period of bid validity or placement of order whichever is later, without any interest.
- 1.15.9. The successful Bidder's bid security will be discharged upon the Bidder furnishing the Performance Security, without any interest. Alternatively, the BS could also be adjusted against Performance Security, if it is paid through Demand Draft / Banker's Cheque.
- 1.15.10. In case a bidder intimates at the time of tender opening in writing that the bid security is kept inside the financial bid, then in such cases, the technical bid of the party would be accepted provisionally till opening of the financial bids with which the party has attached the bid security.

1.15.11. The bid security may be forfeited:

(a)	If Bidder withdraws or amends or modifies or impairs or derogates its bid during the period of bid validity specified by the Bidder on the Bid Form; OR
(b)	In case of successful Bidder, if the Bidder fails to furnish order acceptance within 14 days of the order or fails to sign the contract and / or fails to furnish Performance Security within 14 days from the date of contract / order.

1.15.12. Whenever the bidder chooses to submit the Bid Security in the form of Bank Guarantee, then he should advise the banker issuing the Bank Guarantee to immediately send by Registered Post (A.D.) an unstamped duplicate copy of the Guarantee directly to the Purchaser with a covering letter to compare with the original BG for the correctness, genuineness, etc.

1.16 Period of Validity of Bids

- 1.16.1. Bids shall remain valid for minimum of 90 days after the date of bid opening prescribed by the Purchaser. A bid valid for a shorter period shall be rejected by the Purchaser as non-responsive.
- 1.16.2. In exceptional circumstances, the Purchaser may solicit the Bidder's consent to an extension of the period of validity. The request and the responses thereto shall be made in writing (or by fax or e-mail). The bid security provided shall also be suitably extended. A Bidder may refuse the request without forfeiting its bid security. A Bidder granting the request will not be required nor permitted to modify its bid.
- 1.16.3. Bid evaluation will be based on the bid prices without taking into consideration the above corrections.

1.17 Format and Signing of Bid

- 1.17.1. The bids may be submitted as Single-bid or Two-bid as specified in the Invitation for Bids / NIT through e-procurement system hosted at website <http://www.mstcecommerce.com/eprochome/iitm> as per the process mentioned on the same website.
- 1.17.2. In case the bids are invited on single bid basis, then the Bidder shall submit his / her techno-commercial offer (technical literature / specifications & commercial terms & condition only) in a single bid envelope & shall prepare two copies of the bid, clearly marking each "Original Bid" and "Copy Bid", as appropriate. In the event of any discrepancy between them, the original shall govern. Scan copy of the same (Technical Bid) has also to be uploaded on E-procurement portal. Price bid must be submitted through e-procurement portal only.

- 1.17.3. In case the bids are invited on two-bid system, the Bidder shall submit the bids in two separate parts. First part shall contain Technical bid comprising all documents listed under clause relating to Documents Comprising the Bid excepting bid form and price schedule forms. The second part shall contain the Price-Bid comprising Bid Form and Price Schedule forms. The Bidder shall prepare two copies of the technical bid, clearly marking each "Original Bid" and "Copy Bid", as appropriate & the copies of the documents submitted as a part of Technical Bid in e-procurement system should reach IITM, Pune within 5 working days from the last date of submission of bids on e-procurement system. However, it may please be noted that price bid must be submitted through e-procurement portal only; no hard copy of price bid will be acceptable in any case.
- 1.17.4. The original and all copies of the bid shall be typed or written in indelible ink and shall be signed by the Bidder or a person or persons duly authorized to bind the Bidder to the Contract. All pages of the bid, except for un-amended printed literature, shall be initialled by the person or persons signing the bid.
- 1.17.5. Any interlineations, erasures or overwriting shall be valid only if they are initialled by the person or persons signing the bid.

D. Submission and sealing of Bids

1.18 Submission of Bids

1.18.1. The bidders may submit their bids online on Institute's e-procurement portal hosted at http://www.mstcecommerce.com/eprochome/hild/buyer_login.jsp and duly sealed technical bids (with soft copy) along with Earnest Money Deposit may be submitted generally by post or by hand at the Institute on or before last date of submission of bids.

- a) **The soft copy of the Technical Bid has to be submitted on Institute e-procurement site <http://www.mstcecommerce.com/eprochome/iitm> as per the instruction given at the site.**
- b) Price has to be filled on Institute's e-procurement site <http://www.mstcecommerce.com/eprochome/iitm>. The scanned copy of dully filled in and signed Price Bid has to be uploaded on the above e-procurement site. The prices filled in the e-procurement site will be treated final and shall be binding to the vendor.
- c) Bidders are advised to follow the instructions provided in 'Vendor's Guide' available on the said e-procurement website. For any query / technical help regarding MSTC E-procurement portal, bidders may directly contact to the following officials of MSTC Limited :-
- | | | | | |
|------|------------------------------------|------------------|---|----------------|
| i) | Shri. Tejas, Executive | - (022) 22882854 | / | +91-9535718617 |
| ii) | Shri. Ganesh Yadav, Senior Manager | - (022) 22866261 | / | +91 9869043055 |
| iii) | Smt. Lisbeth Dias, Senior Manager | - (022) 22883501 | / | +91 9820158988 |

1.18.2. Sealing of Bids in the case of bids invited on Single Bid basis:

The Bidder shall mark the Technical Bids as "original" and "copy". The original and copy Bids shall then be sealed in an envelope & shall submit to this Institute not more than 5 days from the last date of submission of bid online.

1.18.3. Sealing of Bids in the case of bids invited on Two bid basis:

- d) Technical Bid should contain documents as listed in Clause- 1.9 **without mentioning Prices** on Bid Form and Price Schedule Form(s). The Bidder shall seal the original Bid and copy Bid, duly marking the Bids as "original" and "copy". The original and copy Bids shall then be sealed in the **Envelope** and marked as **Technical Bid**.
- e) Price Bid should contain Bid Form and Price Schedule Form(s) with Rates / Prices filled in as per Chapter 6. Price Bid must be submitted online only through e-procurement portal.

1.18.4. Marking of Envelopes for submission of Technical Bids :

- a) The Technical bid envelope shall be addressed to the Purchaser indicated in the Special Conditions of Contract (SCC).
- b) The name and address of the bidder, Tender No., due date and a warning "Do not open before _____" to be completed with the time and date as specified in the invitation for bids.

c) Envelope should be super scribed with

- Tender Number: _____
- Due Date_____ Time_____
- Name of the Vendor _____
- Addressed To:
THE DIRECTOR
THE INDIAN INSTITUTE OF TROPICAL METEOROLOGY,
Dr.HOMI BHABHA ROAD, PASHAN,
PUNE-411 008 (MAHARASHTRA)- INDIA

1.18.5. If Technical Bid envelope is not sealed and marked as required above, the Purchaser will assume no responsibility for the bid's misplacement or premature opening of the submitted bid. In such cases, bids received in open condition within the due date and time will be accepted at the risk of the bidder if the same is presented to the Stores & Purchase Officer before expiry of the due date and time of opening of the bids.

1.19 Due date for Submission of Bids

1.19.1. Bids must be received by the Purchaser at the address specified in NIT not later than the time and date specified in NIT. In the event of the specified date for the submission of Bids being declared a holiday for the Purchaser, the Bids will be received up to the appointed time on the next working day.

1.19.2. The Purchaser may, at its discretion, extend the due date for submission of bids by amending the bid documents in accordance with Clause relating to Amendment of Bidding Documents in which case all rights and obligations of the Purchaser and Bidders previously subject to the due date will thereafter be subject to the due date as extended.

1.19.3. The online tender should be submitted strictly as per the terms and conditions and procedures laid down in the website <http://www.mstcecommerce.com/eprochome/iitm> e-procurement portal of the Institute.

1.19.4. Bidders may also refer instructions towards terms and conditions and procedures for bidding through e-procurement portal <http://www.mstcecommerce.com/eprochome/iitm> as per detailed in **Annexure – M.**

1.20 Submission of Bids

1.20.1. Online submission of the bid will not be permitted on the e-procurement portal after expiry of submission time and the bidder shall not be permitted to submit the same by any other mode.

1.20.2. The copies of the documents submitted as a part of Technical Bid in e-procurement system should reach IITM, Pune within 5 working days from the last date of submission of bids on e-procurement system. The bids shall be liable to reject if the document not received within stipulated deadline and the uploaded online bid on the portal shall be considered as non-responsive and shall not be processed further. In case of any discrepancy between online uploaded technical bid and hard copy submitted at this Institute, the online copy shall be considered as final.

1.21 Withdrawal, substitution and Modification of Bids

1.21.1. The Withdrawal, substitution and Modification of Bids is permitted as per the provisions of the e-procurement system.

1.21.2. No bid may be withdrawn, substituted, or modified in the interval between the due date for submission of bids and the expiration of the period of bid validity specified by the Bidder on the Bid Form or any extension thereof.

E. Opening and Evaluation of Bids

1.22 Opening of Bids by the Purchaser

1.22.1. Opening of Bids by the Purchaser will be done as per the provisions of the e-procurement system.

In the event of the specified date of Bid opening being declared a holiday for the Purchaser, the Bids shall be opened at the appointed time and location on the next working day. In case of two-bid, the Price bid shall be opened only after technical evaluation.

1.22.2. Bidders interested in participating in the bid opening process, should witness the tender opening process on e-procurement system.

1.23 Confidentiality

1.23.1. Information relating to the examination, evaluation, comparison, and post qualification of bids, and recommendation of contract award, shall not be disclosed to bidders or any other persons not officially concerned with such process until Award of the Contract.

1.23.2. Any effort by a Bidder to influence the Purchaser in the examination, evaluation, comparison, and post qualification of the bids or contract award decisions may result in the rejection of its Bid.

1.24 Clarification of Bids

To assist in the examination, evaluation, comparison and post qualification of the bids, the Purchaser may, at its discretion, ask the Bidder for a clarification of its bid. The request for clarification and the response shall be in writing and no change in prices or substance of the bid shall be sought, offered or permitted. However, no negotiation shall be held except with the lowest bidder, at the discretion of the purchaser. Any clarification submitted by a bidder in respect to its bid which is not in response to a request by the purchaser shall not be considered.

1.25 Preliminary Examination

1.25.1. The Purchaser shall examine the bids to confirm that all documents and technical documentation requested in **ITB Clause 1.9** have been provided, and to determine the completeness of each document submitted.

1.25.2. The Purchaser shall confirm that the following documents and information have been provided in the Bid. If any of these documents or information is missing, the offer shall be rejected.

(a) All the tenders received will first be scrutinized to see whether the tenders meet the basic requirements as incorporated in the tender enquiry document. The tenders, who do not meet the basic requirements, will be treated as non-responsive and ignored. The following are some of the important points, for which a tender may be declared as non-responsive and will be ignored, during the initial scrutiny:

i	The Bid is unsigned
ii	The Bidder is not eligible
iii	The Bid validity is shorter than the required period
iv	The Bidder has quoted for goods manufactured by a different firm without the required authority letter from the proposed manufacturer
	Bidder has not agreed to give the required performance security
vi	The goods quoted are sub-standard, not meeting the required specification, etc.
vii	Against the Requirement (Scope of supply) the bidder has not quoted for the entire requirement as specified in Chapter 4
viii	The bidder has not agreed to some essential condition(s) incorporated in the tender.

(b) Bid Form and Price Schedule Form, in accordance with **ITB Clause 1.10**. In case of two-bid system these forms shall be examined after opening of the Price Bids of the technically qualified bidders.

1.26 Responsiveness of Bids

1.26.1. Prior to the detailed evaluation, the purchaser will determine the substantial responsiveness of each bid to the bidding documents. For purposes of this clause, a substantive responsive bid is one, which

conforms to all terms and condition of the bidding documents without material deviations, reservations or omissions. A material deviation, reservation or omission is one that:

(a)	affects in any substantial way the scope, quality, or performance of the Goods and Related Services specified in the Tender; OR
(b)	limits in any substantial way, inconsistent with the Bidding Documents, the Purchaser's rights or the Bidder's obligations under the Proposed Contract; OR
(c)	if rectified, would unfairly affect the competitive position of other bidders presenting substantially responsive bids.

1.26.2. The Purchasers' determination of a bid's responsiveness is to be based on the contents of the bid itself without recourse to extrinsic evidence.

1.26.3. If a bid is not substantially responsive, it will be rejected by the Purchaser and may not subsequently be made responsive by the Bidder by correction of the material deviation, reservation or omission.

1.27 Non-Conformity, Error and Omission

1.27.1. Provided that a Bid is substantially responsive, the Purchaser may waive any non-conformities or omissions in the Bid that do not constitute a material deviation.

1.27.2. Provided that a bid is substantially responsive, the Purchaser may request that the Bidder submit the necessary information or documentation, within a reasonable period of time, to rectify non-material non-conformities or omissions in the bid related to documentation requirements. Such omission shall not be related to any aspect of the price of the Bid. Failure of the Bidder to comply with the request may result in the rejection of its Bid.

1.27.3. Provided that the Bid is substantially responsive, the Purchaser shall correct arithmetical errors on the following basis:

(a)	if there is a discrepancy between the unit price and the line item total that is obtained by multiplying the unit price by the quantity, the unit price shall prevail and the line item total shall be corrected, unless in the opinion of the Purchaser there is an obvious misplacement of the decimal point in the unit price, in which case the line item total as quoted shall govern and the unit price shall be corrected;
(b)	if there is an error in a total corresponding to the addition or subtraction of subtotals, the subtotals shall prevail and the total shall be corrected; and
(c)	if there is a discrepancy between words and figures, the amount in words shall prevail, unless the amount expressed in words is related to an arithmetic error, in which case the amount in figures shall prevail subject to (a) and (b) above.

1.27.4. Provided that a bid is substantially responsive, the purchaser may request that a bidder may confirm the correctness of arithmetic errors as done by the purchaser within a target date. In case, no reply is received then the bid submitted shall be ignored and its Bid Security may be forfeited.

1.28 Examination of Terms & Conditions, Technical Evaluation

1.28.1. The Purchaser shall examine the Bid to confirm that all terms and conditions specified in the GCC and the SCC have been accepted by the Bidder without any material deviation or reservation.

1.28.2. The Purchaser shall evaluate the technical aspects of the Bid submitted in accordance with **ITB Clause 1.14**, to confirm that all requirements specified in Chapter 4 of the Bidding Documents have been met without any material deviation or reservation.

1.28.3. If, after the examination of the terms and conditions and the technical evaluation, the Purchaser determines that the Bid is not substantially responsive in accordance with **ITB Clause 1.26**, it shall reject the Bid.

1.29 Conversion to Single Currency

To facilitate evaluation and comparison, the Purchaser will convert all bid prices expressed in the amounts in various currencies in which the bid prices are payable to Indian Rupees at the selling exchange rate established by any bank in India as notified in the Newspapers on the date of bid

opening in the case of single bid and the rates prevalent on the date of opening of the Price Bids in case of two-bid. For this purpose, exchange rate notified in www.rbi.org or any other website would be used by the purchaser.

1.30 Evaluation and comparison of bids

1.30.1. The Purchaser shall evaluate each bid that has been determined, up to this stage of the evaluation, to be substantially responsive.

1.30.2. To evaluate a Bid, the Purchaser shall only use all the factors, methodologies and criteria defined below. No other criteria or methodology will be used.

1.30.3. The bids shall be evaluated on the basis of final landing cost which shall be arrived as under:

(a) For Goods manufactured within India

i)	The price of the goods quoted Ex-works including taxes already paid.
ii)	GST and other taxes like LBT / Octroi etc. which will be payable on the goods if the contract is awarded.
iii)	The charges for inland transportation, insurance and other local services required for delivering the goods at the desired destination as specified in the price schedule form.
iv)	The installation, commissioning and training charges including any incidental services, if any as given in Scope of Supply (Chapter 4)

(b) For Goods manufactured abroad

i)	The price of the goods, quoted on FCA (named Airport abroad) or FOB (named port of shipment), as specified in the price schedule form.
ii)	The charges for insurance and transportation of the goods to the port / place of destination i.e. CIP/CIF Price.
iii)	The agency commission charges payable to Indian agent in Indian rupees, if any.
iv)	The installation, commissioning and training charges including any incidental services, if any

1.30.4. The comparison between the indigenous and the foreign offers shall be made on FOR destination basis and CIF / CIP basis respectively. However, the CIF / CIP prices quoted by any foreign bidder shall be loaded further as under:-

- (a) Towards customs duty and other statutory levies—as per applicable rates.
- (b) Towards custom clearance, inland transportation etc.- 2% of the CIF / CIP value.

Note: Where there is no mention of packing, forwarding, freight, insurance charges, taxes etc. such offers shall be rejected as incomplete.

1.30.5. In case of Purchase of many items against one tender, which are not inter- dependent or, where compatibility is not a problem, normally the comparison would be made on ex-works, (in case of indigenous items) and on FOB / FCA (in the case of imports) prices quoted by the firms for identifying the lowest quoting firm for each item.

1.30.6. Orders for Imported Goods need not necessarily be on FOB / FCA basis rather it can be on the basis of any of the Incoterms latest edition as may be amended from time to time by the ICC or any other designated authority and favourable to IITM.

1.30.7. Wherever the price quoted on FOB / FCA and CIF / CIP basis are the same, the Contract would be made on CIF / CIP basis only.

1.30.8. The GCC and the SCC shall specify the mode of transport i.e. whether by air / ocean / road / rail.

1.31 Comparison of Bids

The Purchaser shall compare all substantially responsive bids to determine the lowest valued bid, in accordance with **ITB Clause 1.30**.

1.32 Contacting the Purchaser

1.32.1. Subject to **ITB Clause 1.24**, no Bidder shall contact the Purchaser on any matter relating to its bid, from the time of the bid opening to the time the Contract is awarded.

1.32.2. Any effort by a Bidder to influence the Purchaser in its decisions on bid evaluation, bid comparison or contract award may result in rejection of the Bidder's bid.

1.33 Post qualification

- 1.33.1. In the absence of pre-qualification, the Purchaser will determine to its satisfaction whether the Bidder that is selected as having submitted the lowest evaluated responsive bid is qualified to perform the contract satisfactorily, in accordance with the criteria listed in **ITB Clause 1.13**.
- 1.33.2. The determination will take into account the Eligibility & Qualification criteria listed in the bidding documents and will be based upon an examination of the documentary evidence of the Bidder's qualifications submitted by the Bidder, as well as such other information as the Purchaser deems necessary and appropriate.
- 1.33.3. An affirmative determination will be a prerequisite for award of the contract to the Bidder. A negative determination will result in rejection of the Bidder's bid.

F. Award of contract

1.34 Negotiations

Normally, there shall not be any negotiation. Negotiations, if at all, shall be an exception and only in the case of items with limited source of supply. Negotiations shall be held with the lowest evaluated responsive bidder. Counter offers tantamount to negotiations, shall be treated at par with negotiations.

1.35 Award Criteria

Subject to **ITB Clause 1.37**, the Purchaser will award the contract to the successful Bidder whose bid has been determined to be substantially responsive and has been determined to be the lowest evaluated bid, provided further that the Bidder is determined to be qualified to perform the contract satisfactorily. The details of the award would be hosted on the website of the Purchaser.

1.36 Purchaser's right to vary Quantities at Time of Award or later

The Purchaser reserves the right at the time of Contract award to increase or decrease the quantity of goods and services originally specified in the Chapter 4 without any change in unit price or other terms and conditions. Further, at the discretion of the purchaser, the quantities in the contract may be enhanced by 25% within the delivery period.

1.37 Purchaser's right to accept any Bid and to reject any or all Bids

The Purchaser reserves the right to accept or reject any bid, and to annul the bidding process and reject all bids at any time prior to award of Contract, without thereby incurring any liability to the affected Bidder or Bidders.

1.38 Notification of Award

- 1.38.1. Prior to the expiration of the period of bid validity, the Purchaser will notify the successful bidder in writing by registered letter or by cable or telex or fax or e mail that the bid has been accepted and a separate purchase order shall follow through post.
- 1.38.2. Until a formal contract is prepared and executed, the notification of award should constitute a binding contract.
- 1.38.3. Upon the successful Bidder's furnishing of the signed Contract Form and Performance Security pursuant to **ITB Clause 1.41**, the Purchaser will promptly notify each unsuccessful Bidder and discharge its bid security.

1.39 Signing of Contract

- 1.39.1. Promptly after notification, the Purchaser shall send the successful Bidder the Purchase Order.
- 1.39.2. Within twenty-one (14) days of date of the Purchase Order, the successful Bidder shall enter into Contract Agreement as per Chapter 7.

1.40 Order Acceptance

- 1.40.1. The successful bidder should submit Order acceptance within 14 days from the date of issue of Purchase Order, failing which it shall be presumed that the vendor is not interested and his bid security is liable to be forfeited pursuant to **ITB Clause 1.15.11**.
- 1.40.2. The order acceptance must be received within 14 days. However, the Purchaser has the powers to extend the time frame for submission of order acceptance and submission of Performance Security

(PS). Even after extension of time, if the order acceptance / PS are not received, the contract shall be cancelled and limited tenders irrespective of the value shall be invited from the responding firms after forfeiting the bid security of the defaulting firm, where applicable, provided there is no change in specifications. In such cases the defaulting firm shall not be considered again for re-tendering in the particular case.

1.41 Performance Security

Within 14 days of receipt of the notification of award / Purchase Order as per the GCC Clause 2.12, the Supplier shall furnish Performance Security for the amount specified in SCC, valid for the time 60 days after the warranty period.

CHAPTER 2
CONDITIONS OF CONTRACT
GENERAL CONDITIONS OF CONTRACT

Clause No.	Contents	Page No.
2.1	Definitions	19
2.2	Contract Documents	19
2.3	Fraud and Corruption	19
2.4	Joint Venture, Consortium or Association / Amalgamation / Acquisition, Patent Indemnity	20
2.5	Scope of Supply	20
2.6	Suppliers' Responsibilities	20
2.7	Contract price	20
2.8	Copy Right	20
2.9	Application	21
2.10	Standards	21
2.11	Use of Contract Documents and Information	21
2.12	Performance Security	21
2.13	Installation, Commissioning, Demonstration, Inspection and Tests	22
2.14	Packing	22
2.15	Delivery and Documents	22
2.16	Insurance	23
2.17	Transportation	24
2.18	Incidental Services	24
2.19	Spare Parts	24
2.20	Warranty	24
2.21	Terms of Payment	26
2.22	Change Orders and Contract Amendments	26
2.23	Assignment	26
2.24	Subcontracts	26
2.25	Extension of time	26
2.26	Penalty Clause	27
2.27	Termination for Default	27
2.28	Force Majeure	27
2.29	Termination for insolvency	27
2.30	Termination for Convenience	28
2.31	Settlement of Disputes	28
2.32	Governing Language	28
2.33	Applicable Law	29
2.34	Notices	29
2.35	Taxes and Duties	29
2.36	Right to use Defective Goods	29
2.37	Protection against Damage	29
2.38	Site preparation and installation	29
2.39	Integrity Pact	29

Note: The General Conditions of Contract shall form the part of Purchase Order / Contract.

A.GENERAL CONDITIONS OF CONTRACT

2.1. Definitions

The following words and expressions shall have the meanings hereby assigned to them:

Sr. No.	Words / Expressions	Meaning
(a)	Contract	The Contract Agreement entered into between the Purchaser and the Supplier, together with the Contract Documents referred to therein, including all attachments, appendices, and all documents incorporated by reference therein.
(b)	Contract Documents	The documents listed in the Contract Agreement, including any amendments thereto.
(c)	Contract Price	The price payable to the Supplier as specified in the Contract Agreement, subject to such additions and adjustments thereto or deductions there from, as may be made pursuant to the Contract.
(d)	Day	Calendar day
(e)	Completion	The fulfilment of the Related Services by the Supplier in accordance with the terms and conditions set forth in the Contract.
(f)	GCC	The General Conditions of Contract.
(g)	Goods	All of the commodities, raw material, machinery and equipment, and/or other materials that the Supplier is required to supply to the Purchaser under the Contract
(h)	Services	The services incidental to the supply of the goods, such as transportation, insurance, installation, training and initial maintenance and other such obligations of the Supplier under the Contract.
(i)	SCC	The Special Conditions of Contract.
(j)	Subcontractor	Any natural person, private or government entity, or a combination of the above, to which any part of the Goods to be supplied or execution of any part of the Related Services is subcontracted by the Supplier.
(k)	Supplier	The natural Person, Private or Government entity, or a combination of the above, whose bid to perform the Contract has been accepted by the Purchaser and is named as such in the Contract Agreement.
(l)	Purchaser	The Director, The Indian Institute of Tropical Meteorology (IITM), Pune an autonomous body under Ministry of Earth Sciences (MoES), Govt. of India. as specified in SCC
(m)	The final destination	The place named in the SCC.

2.2 Contract Documents

2.2.1 Subject to the order of precedence set forth in the Contract Agreement, all documents forming the Contract (and all parts thereof) are intended to be correlative, complementary, and mutually explanatory. The Contract Agreement shall be read as a whole.

2.2.2 Successful bidder shall have to enter into Contract Agreement on Rs.500/- non judicial stamp paper as per Contract Form given in Chapter 7 within 14 days of placement of Purchase Order having value above Rs. 25 lakh or equivalent amount in Foreign Currency.

2.3 Fraud and Corruption

The purchaser requires that bidders, suppliers, contractors and consultants, if any, observe the highest standard of ethics during the procurement and execution of such contracts. In pursuit of this policy,

(a) The terms set forth below are defined as follows:

I	Corrupt practice	The offering, giving, receiving, or soliciting, directly or indirectly, of anything of value to influence the action of a public official in the procurement process or in contract execution
II	Fraudulent practice	A misrepresentation or omission of facts in order to influence a procurement process or the execution of a contract
III	Collusive practice	A scheme or arrangement between two or more bidders, with or without the knowledge of the Borrower, designed to establish bid prices at artificial,

		non-competitive levels
IV	Coercive practice	Harming or threatening to harm, directly or indirectly, persons or their property to influence their participation in the procurement process or affect the execution of a contract

- (b) The purchaser will reject a proposal for award if it determines that the Bidder recommended for award has, directly or through an agent, engaged in corrupt, fraudulent, collusive or coercive practices in competing for the Contract in question.

2.4 Joint Venture, Consortium or Association/Amalgamation/Acquisition, Patent Indemnity etc.

If the Supplier is a joint venture, consortium, or association, all of the parties shall be jointly and severally liable to the Purchaser for the fulfilment of the provisions of the Contract and shall designate one party to act as a leader with authority to bind the joint venture, consortium, or association. The composition or the constitution of the joint venture, consortium, or association shall not be altered without the prior consent of the Purchaser.

2.4.1. Amalgamation/Acquisition etc.:

In the event the Manufacturer/Supplier proposes for amalgamation, acquisition or sale its business to any firm during the contract period, the Buyer/Successor of the Principal Company are liable for execution of the contract and also fulfilment of contractual obligations i.e. supply, installation, commissioning, warranty, maintenance/replacement of spares accessories etc. You may confirm this condition while submitting the bid.

2.4.2 Indemnity Bond

In order to safeguard the interest of IITM, the supplier should submit Indemnity Bond as given in Chapter-8 (Annexure-J) on Rs.500/- non judicial stamp paper within 14 days of placing of the order for Purchase Order having value above Rs. 25 lakh or equivalent amount in Foreign Currency.

2.4.3 Patent Indemnity

- a) The Supplier shall, subject to the Purchaser's compliance with GCC Sub-Clause 2.4.3(a), indemnify and hold harmless the Purchaser and its employees and officers from and against any and all suits, actions or administrative proceedings, claims, demands, losses, damages, costs, and expenses of any nature, including attorney's fees and expenses, which the Purchaser may suffer as a result of any infringement or alleged infringement of any patent, utility model, registered design, trademark, copyright, or other intellectual property right registered or otherwise existing at the date of the Contract by reason of:

(I)	the installation of the Goods by the Supplier or the use of the Goods in India
AND	
(II)	the sale in any country of the products produced by the Goods

- b) If any proceedings are brought or any claim is made against the Purchaser, the Purchaser shall promptly give the Supplier a notice thereof and the Supplier may at its own expense and in the Purchaser's name conduct such proceedings or claim and any negotiations for the settlement of any such proceedings or claims.

2.5 Scope of Supply

Scope of Supply (i.e. the Goods to be supplied and Related Services to be performed) shall be as specified in the Chapter-4 clause 4.2

2.6 Suppliers' Responsibilities

The Supplier shall supply all the Goods and perform all Related Services included in the Scope of Supply-Clause 2.5 of the GCC and the Delivery & Completion Schedule, as per GCC Clause 2.15 relating to delivery and document.

2.7 Contract price

Prices charged by the Supplier for the Goods supplied and the Related Services performed under the Contract shall not vary from the prices quoted by the Supplier in its bid.

2.8 Copy Right

The copyright in all drawings, documents, and other materials containing data and information furnished to the Purchaser by the Supplier herein shall remain vested in the Supplier, or, if they are furnished to the Purchaser directly or through the Supplier by any third party, including suppliers of materials, the copyright in such materials shall remain vested in such third party

2.9 Application

These General Conditions shall apply to the extent that they are not superseded by provisions in other parts of the Contract.

2.10 Standards

The Goods supplied and services rendered under this Contract shall conform to the standards mentioned in the Technical Specifications and Schedule of Requirements, and, when no applicable standard is mentioned, to the authoritative standard appropriate to the Goods' country of origin and such standards shall be the latest issued by the concerned institution.

2.11 Use of Contract Documents and Information

2.11.1 The Supplier shall not, without the Purchaser's prior written consent, disclose the Contract, or any provision thereof, or any specification, plan, drawing, pattern, sample or information furnished by or on behalf of the Purchaser in connection therewith, to any person other than a person employed by the Supplier in performance of the Contract. Disclosure to any such employed person shall be made in confidence and shall extend only so far, as may be necessary for purposes of such performance.

2.11.2 The Supplier shall not, without the Purchaser's prior written consent, make use of any document or information enumerated above except for purposes of performing the Contract.

2.11.3 Any document, other than the Contract itself, enumerated above shall remain the property of the Purchaser and shall be returned (in all copies) to the Purchaser on completion of the Supplier's performance under the Contract if so required by the Purchaser.

2.12 Performance Security (PS)

2.12.1 Within 14 days of receipt of the notification of award of contract / Purchase Order, the Supplier shall furnish performance security in the amount specified in SCC, valid till 60 days after the warranty period. Alternatively, the PS may also be submitted at the time of release of final payment in cases where part payment is made against delivery & part on installation. The PS, where applicable, shall be submitted in advance for orders where full payment is to be made on Letter of Credit (LC) or on delivery. In this case, submission of PS at the time of negotiation of documents through Bank would be stipulated as a condition in the LC and the BS should be kept valid till such time the PS is submitted.

2.12.2 The proceeds of the performance security shall be payable to the Purchaser as compensation for any loss resulting from the Supplier's failure to complete its obligations under the Contract.

2.12.3 The Performance Security shall be denominated in Indian Rupees for the offers received for supplies within India and denominated in the currency of the contract in the case of offers received for supply from foreign countries.

2.12.4 In the case of imports, the PS may be submitted either by the principal or by the Indian agent and, in the case of purchases from indigenous sources, the PS may be submitted by either the manufacturer or their authorized dealer / bidder.

2.12.5 The Performance security shall be in one of the following forms:

(a)	A Bank guarantee or stand-by Letter of Credit issued by a Nationalized / Scheduled bank located in India or a bank located abroad in the form provided in the bidding documents.
OR	
(b)	A Banker's cheque or Account Payee demand draft in favour of the purchaser.

2.12.6 The performance security will be discharged by the Purchaser and returned to the Supplier not later than 60 days following the date of completion of the Supplier's performance obligations, including any warranty obligations, unless specified otherwise in SCC, without levy of any interest.

- 2.12.7 In the event of any contract amendment, the supplier shall, within 14 days of receipt of such amendment, furnish the amendment to the performance security, rendering the same valid for the duration of the contract, as amended for further period of 60 days thereafter.
- 2.12.8 The order confirmation should be received within 15 days from the date of notification of award. However, the Purchaser has the powers to extend the time frame for submission of order confirmation and submission of Performance Security (PS). Even after extension of time, if the order acceptance and PS are not received, the contract shall be cancelled and limited tenders irrespective of the value would be invited from the responding firms after forfeiting the bid security of the defaulting firm, where applicable provided there is no change in specifications. In such cases the defaulting firm would not be considered again for re-tendering in the particular case.
- 2.12.9 Whenever, the bidder chooses to submit the Performance Security in the form of Bank Guarantee, and then he should advise the banker issuing the Bank Guarantee to immediately send by Registered Post (A.D.) an unstamped duplicate copy of the Guarantee directly to the Purchaser with a covering letter to compare with the original BG for the correctness, genuineness, etc.

2.13 Installation, Commissioning, Demonstration, Inspections and Tests

Bidder shall be responsible for Installation, Commissioning, Demonstration, Inspections and Tests wherever applicable and for after sales service during the warranty and thereafter as specified in Chapter 4.

2.14 Packing

- 2.14.1. The Supplier shall provide such packing of the Goods as is required to prevent their damage or deterioration during transit to their final destination as indicated in the Contract. The packing shall be sufficient to withstand, without limitation, rough handling during transit and exposure to extreme temperatures, salt and precipitation during transit and open storage. Packing case size and weights shall take into consideration, where appropriate, the remoteness of the Goods' final destination and the absence of heavy handling facilities at all points in transit.
- 2.14.2. The packing, marking and documentation within and outside the packages shall comply strictly with such special requirements as shall be provided for in the Contract including additional requirements, if any, specified in SCC and in any subsequent instructions ordered by the Purchaser.

2.15 Delivery and Documents

- 2.15.1. Delivery of the Goods and completion and related services shall be made by the Supplier in accordance with the terms specified by the Purchaser in the contract. The details of shipping and/or other documents to be furnished by the supplier are as given below or /and as specified in SCC.

Details of Shipping and other Documents to be furnished by the Supplier are :	
A)	For goods manufactured or supplied from within India
	Within 24 hours of dispatch, the supplier shall notify the purchaser the complete details of dispatch and also supply following documents by registered post / speed post and copies thereof by FAX/email
(a)	Three copies of Supplier's Invoice indicating, inter-alia description and specification of the goods, quantity, unit price, total value
(b)	Packing list
(c)	Certificate of country of origin
(d)	Insurance certificate, if required under the contract
(e)	Railway receipt/Consignment note
(f)	Manufacturer's warrantee certificate and in-house inspection certificate, if any
(g)	Inspection certificate issued by purchaser's inspector, if any
(h)	Any other document(s) as and when required in terms of the contract
NOTE:	
1	The nomenclature used for the item description in the invoice(s), packing list(s) and the delivery note(s) etc. should be identical to that used in the contract. The dispatch particulars including the name of the transporter should also be mentioned in the Invoice(s).
2	The above documents should be received by the Purchaser before arrival of the Goods and, if not received, the Supplier will be responsible for any consequent expenses.
B)	For goods manufactured or supplied from abroad
	Within 24 hours of dispatch, the supplier shall notify the purchaser the complete details of

	dispatch and also supply following documents by Registered Post / courier and copies thereof by FAX.
(a)	Three copies of supplier's Invoice giving full details of the goods including quantity, value, etc.
(b)	Packing list
(c)	Certificate of country of origin
(d)	Manufacturer's warrantee and Inspection certificate, if any
(e)	Inspection certificate issued by the Purchaser's Inspector, if any
(f)	Insurance Certificate, if required under the contract
(g)	Name of the Vessel / Carrier
(h)	Bill of Lading / Airway Bill
(i)	Port of Loading
(j)	Date of Shipment
(k)	Port of Discharge & expected date of arrival of goods
(l)	Any other document(s) as and when required in terms of the contract
NOTE:	
1	The nomenclature used for the item description in the invoice(s), packing list(s) and the delivery note(s) etc. should be identical to that used in the contract. The dispatch particulars including the name of the transporter should also be mentioned in the Invoice(s).
2	The above documents should be received by the Purchaser before arrival of the Goods and, if not received, the Supplier will be responsible for any consequent expenses.
	The clearing of the consignment at Mumbai Airport shall be done by our authorized Custom House Agents (CHA). The corresponding shipping documents may be forwarded to them accordingly. It is advised to give us and our CHA, a pre-alert before the consignment is dispatched. If there is delay in clearing of the consignment for <u>not</u> giving timely pre-alert then demurrage (Ware house charges), if applicable has to be refunded to us.

2.15.2. The terms FOB, FCA, CIF, CIP etc. shall be governed by the rules prescribed in the current edition of the Incoterms published by the International Chambers of Commerce (ICC), Paris.

2.15.3. The mode of transportation shall be as specified in SCC.

2.15.4. The Bidders may please note that the delivery of the system should be strictly within delivery schedule mentioned in the Chapter-4 / Purchase Order.

2.15.5. Goods should not be dispatched until the vendor receives a firm Purchase Order

2.16 Insurance

2.16.1. Indigenous goods, the Goods supplied under the Contract shall be fully insured in Indian Rupees against any loss or damage incidental to manufacture or acquisition, transportation, storage and delivery in the manner specified in SCC.

2.16.2. Where delivery of the goods is required by the purchaser on CIF / CIP basis for imported goods or FOR destination for Indigenous goods, the supplier shall arrange and pay for Marine / Transit Insurance, naming the purchaser as beneficiary and initiate & pursue claims till settlement, in the event of any loss or damage.

2.16.3. Where delivery is on FOB or FCA basis for imported goods or FOR dispatch station for indigenous goods, then insurance would be the responsibility of the purchaser.

2.16.4. The equipment to be supplied will be insured by the supplier against all risks of loss or damage from the date of shipment till such time it is delivered at IITM site in case of Rupee transaction

2.16.5. With a view to ensure that claims on insurance companies, if any, are lodged in time, the Bidders and / or the Indian agent shall be responsible for follow up with their principals for ascertaining the dispatch details and informing the same to the Purchaser and he shall also liaise with the Purchaser to ascertain the arrival of the consignment after clearance so that immediately thereafter in his presence the consignment could be opened and the insurance claim be lodged, if required, without any loss of time. Any delay on the part of the Bidder / Indian Agent would be viewed seriously and he shall be directly responsible for any loss sustained by the Purchaser on the event of the delay.

2.17 Transportation

- 2.17.1. Where the Supplier is required under the Contract to deliver the Goods on FOB basis, transport of the Goods, up to and including the point of putting the Goods on board the vessel at the specified port of loading, shall be arranged and paid for by the Supplier, and the cost thereof shall be included in the Contract price. Where the Supplier is required under the Contract to deliver the Goods on FCA basis, transport of the Goods and delivery into the custody of the carrier at the place named by the Purchaser or other agreed point shall be arranged and paid for by the Supplier, and the cost thereof shall be included in the Contract price.
- 2.17.2. Where the Supplier is required under the Contract to deliver the Goods CIF or CIP, transport of the Goods to the port of destination or such other named place of destination in the Purchaser's country, as shall be specified in the Contract, shall be arranged and paid for by the Supplier, and the cost thereof shall be included in the Contract Price.
- 2.17.3. In the case of supplies from within India, where the Supplier is required under the Contract to transport the Goods to a specified destination in India, defined as the Final Destination, transport to such destination, including insurance and storage, as specified in the Contract, shall be arranged by the Supplier, and the related costs shall be included in the Contract Price.
- 2.17.4. The clearing of the consignment at Mumbai Airport shall be done by our authorized Custom House Agents (CHA) for CIP / CIF consignments. The details of CHA will be given in the Purchase Order. The corresponding shipping documents may be forwarded to them accordingly. It is advised to give us and our CHA, a pre-alert before the consignment is dispatched. If there is delay in clearing of the consignment for not giving timely pre-alert then demurrage (Ware house charges), if applicable has to be refunded to us by the Supplier / Indian Agent or the same will be deducted from any payment due to Supplier / Indian Agent against this order or any other Purchase order.

2.18 Incidental Services

The supplier may be required to provide any or all of the services, including training, if any, as specified in **Chapter 4: Clause-4.2**.

2.19 Spare Parts

The Supplier shall be required to provide any or all of the following materials, notifications, and information pertaining to spare parts manufactured or distributed by the Supplier:

(a)	Such spare parts as the Purchaser may elect to purchase from the Supplier, providing that this election shall not relieve the Supplier of any warranty obligations under the Contract; and
(b)	In the event of termination of production of the spare parts:
	(i) Advance notification to the Purchaser of the pending termination, in sufficient time to permit the Purchaser to procure needed requirements; and
	(ii) Following such termination, furnishing at no cost to the Purchaser, the blueprints, drawings and specifications of the spare parts, if requested.

2.20 Warranty

- a) The Supplier warrants that all the Goods are new, unused, and of the most recent or current models, and that they incorporate all recent improvements in design and materials, unless provided otherwise in the Contract.
- b) The Supplier further warrants that the Goods shall be free from defects arising from any act or omission of the Supplier or arising from design, materials, and workmanship, under normal use in the conditions prevailing in India.
- c) **Unless otherwise specified in the SCC**, the warranty shall remain valid for Twelve (12) months after the Goods, or any portion thereof as the case may be, have been delivered to and accepted at the final destination indicated in the SCC, or for Eighteen (18) months after the date of shipment from the port or place of loading in the country of origin, whichever period concludes earlier.
- d) The warranty on the associated software should cover providing of upgraded version/s, if any, released during the warranty period free of cost.

- e) The bidder shall assure the supply of spare parts after warranty is over for maintenance of the equipment supplied if and when required for a period of 10 years from the date of supply of equipment on payment on approved price list basis.
- f) The equipment must be supported by a Service Centre manned by the principal vendor's technical support engineers. The support through this Centre must be available 24 hours in a day, seven days a week and 365 days a year. Also it should be possible to contact the Principal's vendor support Centre on a toll free number/web/mail.
- g) An undertaking from the manufacturer is required in this regard stating that they would facilitate the Bidder, Service provider on regular basis with technology / product updates & extend support for the warranty as well.
- h) Supplier will have to arrange for all the testing equipment & tools required for installation, testing & maintenance etc.
- i) The Principal Supplier must have a local logistics support by maintaining a local spares depot in the country of deployment of the equipment. This is to ensure immediate delivery of spares parts from Principal Supplier of equipment to its channel partner/system integrator.
- j) Details of onsite warranty, Name of Agency that shall maintain during warranty and undertake Annual Maintenance Contract/Comprehensive Service Maintenance Contract beyond warranty shall be given in the offer. In case of foreign quote, the name of Indian Agent who shall maintain during warranty and AMC beyond warranty shall be given in the Technical Offer.
- k) The Purchaser shall give notice to the Supplier stating the nature of any such defects together with all available evidence thereof, promptly following the discovery thereof. The Purchaser shall afford all reasonable opportunity for the Supplier to inspect such defects.
- l) Upon receipt of such notice, the Supplier shall, within a reasonable period of time, expeditiously repair or replace the defective Goods or parts thereof, at no cost to the Purchaser.
- m) If having been notified, the Supplier fails to remedy the defect within a reasonable period of time; the Purchaser may proceed to take within a reasonable period such remedial action as may be necessary, at the Supplier's risk and expense and without prejudice to any other rights which the Purchaser may have against the Supplier under the Contract.
- n) In case the Equipment / System remains non-operational or performs below the desired level for more than 1 week after intimation of the fault in the Equipment / System then Warranty period shall be extended for further period for which Equipment / System remained non-operational or performed below the desired level, without prejudice to any other terms and conditions of the Contract.
- o) The defects, if any, during the warranty period are to be rectified free of charge by arranging free replacement wherever necessary.
- p) In case of any replacement during the warranty period the same shall be made free of cost i.e. DDP for import replacement and/or free delivery to IITM for indigenous replacement. All the duties / taxes relating to these replacements have to be borne by the supplier. Dispatch details of such warranty replacements have to be informed in advance to enable us to provide documents for custom clearance.
- q) Any replacements during warranty period should be free of cost. If the defective item has to be sent back to the Principal Supplier, for such replacements / returns to the Principal Supplier / Indian Agent has to bear documentation charges. If the cost of replacement is upto Rs. 5 Lakh then the documentation charges will be Rs. 5,000 and above Rs. 5 Lakh it is Rs. 10,000. Such charges have to be paid in favour of The Director, IITM, Pune. These charges are only for documentation. Any charges regarding packing, forwarding, freight, insurance, etc. should be borne by the Principal supplier / Indian Agent for returning of defective items. In other words, any warranty replacement has to be done immediately/within a week (7 days) without expecting IITM to export the defective items to Principal supplier for repair/replacements. All charges involved for re-export of defective items have to be borne by Principal supplier / Indian Agent.

2.21 Terms of Payment

- 2.21.1. The method and conditions of payment to be made to the Supplier under this Contract shall be as specified in the SCC.
- 2.21.2. The Supplier's request(s) for payment shall be made to the Purchaser in writing, accompanied by an invoice describing, as appropriate, the Goods delivered and the Services performed, and by documents, submitted pursuant to Delivery and document Clause of the GCC and upon fulfilment of other obligations stipulated in the contract.
- 2.21.3. Payments shall be made promptly by the Purchaser but in no case later than thirty (30) days after submission of the Invoice or claim by the Supplier.
- 2.21.4. Payment shall be made in currency as indicated in the contract.

2.22 Change Orders and Contract Amendments

2.22.1. The Purchaser may at any time, by written order given to the Supplier pursuant to Clause on Notices of the GCC make changes within the general scope of the Contract in any one or more of the following:

a)	Drawings, designs, or specifications, where Goods to be furnished under the Contract are to be specifically manufactured for the Purchaser;
b)	The method of shipping or packing;
c)	The place of delivery; and/or
d)	The Services to be provided by the Supplier.
e)	The delivery schedule.

- 2.22.2. If any such change causes an increase or decrease in the cost of, or the time required for, the Supplier's performance of any provisions under the Contract, an equitable adjustment shall be made in the Contract Price or delivery schedule, or both, and the Contract shall accordingly be amended. Any claims by the Supplier for adjustment under this clause must be ascertained within fifteen (15) days from the date of the Supplier's receipt of the Purchaser's change order.
- 2.22.3. No variation or modification in the terms of the contract shall be made except by written amendment signed by the parties.

2.23 Assignment

The Supplier shall not assign, in whole or in part, its obligations to perform under the Contract, except with the Purchaser's prior written consent.

2.24 Subcontracts

The Supplier shall notify the Purchaser in writing of all subcontracts awarded under this Contract if not already specified in the bid. Such notification, in the original bid or later, shall not relieve the Supplier from any liability or duties or obligation under the Contract.

2.25 Extension of time

- 2.25.1. Delivery of the Goods and performance of the Services shall be made by the Supplier in accordance with the Delivery schedule specified by the Purchaser.
- 2.25.2. If at any time during performance of the Contract, the Supplier or its sub-contractor(s) should encounter conditions impeding timely delivery of the Goods and performance of Services, the Supplier shall promptly notify the Purchaser in writing of the fact of the delay, its likely duration and its cause(s). As soon as practicable after receipt of the Supplier's notice, the Purchaser shall evaluate the situation and may, at its discretion, extend the Supplier's time for performance with or without penalty, in which case the extension shall be ratified by the parties by amendment to the Contract.
- 2.25.3. Except as provided under the Force Majeure clause of the GCC, a delay by the Supplier in the performance of its delivery obligations shall render the Supplier liable to the imposition of penalty pursuant to Penalty Clause of the GCC unless an extension of time is agreed upon pursuant to above clause without the application of penalty clause.

2.26 Penalty clause

Subject to GCC Clause on Force Majeure, if the Supplier fails to deliver any or all of the Goods or to perform the Services within the period(s) specified in the Contract, the Purchaser shall, without prejudice to its other remedies under the Contract, deduct from the Contract Price, as penalty, a sum equivalent to the percentage specified in SCC of the delivered price of the delayed Goods or unperformed Services or contract value for each week or part thereof of delay until actual delivery or performance, up to a maximum deduction of the Percentage specified in SCC. Once the maximum is reached, the Purchaser may consider termination of the Contract pursuant to GCC Clause on Termination for Default. The SCC shall also indicate the basis for ascertaining the value on which the penalty shall be applicable.

2.27 Termination for Default

2.27.1. The Purchaser may, without prejudice to any other remedy for breach of contract, by written notice of default sent to the Supplier, terminate the Contract in whole or part:

(a)	If the Supplier fails to deliver any or all of the Goods within the period(s) specified in the contract, or within any extension thereof granted by the Purchaser pursuant to GCC Clause on Extension of Time;
(b)	If the Supplier fails to perform any other obligation(s) under the Contract
(c)	If the Supplier, in the judgment of the Purchaser has engaged in corrupt or fraudulent or collusive or coercive practices as defined in GCC Clause on Fraud or Corruption in competing for or in executing the Contract.

2.27.2. In the event the purchaser terminates the contract in whole or in part, he may take recourse to any one or more of the following action:

(a)	The Performance Security/EMD will be forfeited;
(b)	The Purchaser may procure, upon such terms and in such manner as it deems appropriate, Goods similar to those undelivered, and the supplier shall be liable for all available actions against it in terms of the contract.
(c)	However, the supplier shall continue to perform the contract to the extent not terminated.

2.28 Force Majeure

2.28.1. Notwithstanding the provisions of GCC Clauses relating to Extension of Time, Penalty and Termination for Default the Supplier shall not be liable for forfeiture of its Performance Security, Liquidated Damages or Termination for Default, if and to the extent that, its delay in performance or other failure to perform its obligations under the Contract is the result of an event of Force Majeure.

2.28.2. For purposes of this Clause, "Force Majeure" means an event or situation beyond the control of the Supplier that is not foreseeable, is unavoidable, and its origin is not due to negligence or lack of care on the part of the Supplier. Such events may include, but not be limited to, acts of the Purchaser in its sovereign capacity, wars or revolutions, fires, floods, epidemics, quarantine restrictions, and freight embargoes.

2.28.3. If a Force Majeure situation arises, the Supplier shall promptly notify the Purchaser in writing of such conditions and the cause thereof within 21 days of its occurrence. Unless otherwise directed by the Purchaser in writing, the Supplier shall continue to perform its obligations under the Contract as far as is reasonably practical, and shall seek all reasonable alternative means for performance not prevented by the Force Majeure event.

2.28.4. If the performance in whole or in part or any obligations under the contract is prevented or delayed by any reason of Force Majeure for a period exceeding 60 days, either party may at its option terminate the contract without any financial repercussions on either side.

2.29 Termination for Insolvency

The Purchaser may at any time terminate the Contract by giving written notice to the Supplier, if the Supplier becomes bankrupt or otherwise insolvent. In this event, termination will be without compensation to the Supplier, provided that such termination will not prejudice or affect any right of action or remedy, which has accrued or will accrue thereafter to the Purchaser.

2.30 Termination for Convenience

- 2.30.1. The Purchaser, by written notice sent to the Supplier, may terminate the Contract, in whole or in part, at any time. The notice of termination shall specify that termination is for the Purchaser's convenience, the extent to which performance of the Supplier under the Contract is terminated, and the date upon which such termination becomes effective.
- 2.30.2. The Goods that are complete and ready for shipment within 30 days after the Supplier's receipt of notice of termination shall be accepted by the Purchaser at the Contract terms and prices. For the remaining Goods, the Purchaser may elect:

(a)	To have any portion completed and delivered at the Contract terms and prices ; and / or
(b)	To cancel the remainder and pay to the Supplier an agreed amount for partially completed Goods / Services and for materials and parts previously procured by the Supplier.

2.31 Settlement of Disputes

- 2.31.1. The Purchaser and the supplier shall make every effort to resolve amicably by direct informal negotiation any disagreement or dispute arising between them under or in connection with the Contract.
- 2.31.2. If, after twenty-one (21) days, the parties have failed to resolve their dispute or difference by such mutual consultation, then either the Purchaser or the Supplier may give notice to the other party of its intention to commence arbitration, as hereinafter provided, as to the matter in dispute, and no arbitration in respect of this matter may be commenced unless such notice is given. Any dispute or difference in respect of which a notice of intention to commence arbitration has been given in accordance with this Clause shall be finally settled by arbitration. Arbitration may be commenced prior to or after delivery of the Goods under the Contract. .
- 2.31.3. The dispute settlement mechanism / arbitration proceedings shall be concluded as under:

(a)	In case of Dispute or difference arising between the Purchaser and a domestic supplier relating to any matter arising out of or connected with this agreement, such disputes or difference shall be settled in accordance with the Indian Arbitration & Conciliation Act, 1996, the rules there under and any statutory modifications or re-enactments thereof shall apply to the arbitration proceedings. The dispute shall be referred to the Director The Indian Institute of Tropical Meteorology (IITM), Pune and if he is unable or unwilling to act, to the sole arbitration of some other person appointed by him willing to act as such Arbitrator. The award of the arbitrator so appointed shall be final, conclusive and binding on all parties to the Contract.
(b)	In the case of a dispute between the purchaser and a Foreign Supplier, the dispute shall be settled by arbitration In accordance with provision of sub-clause (a) above. But if this is not acceptable to the supplier then the dispute shall be settled in accordance with provisions of UNCITRAL (United Nations Commission on International Trade Law) Arbitration Rules.

- 2.31.4. The venue of the arbitration shall be the place from where the Purchase Order or Contract is issued.
- 2.31.5. Notwithstanding any reference to arbitration herein,

(a)	the parties shall continue to perform their respective obligations under the Contract unless they otherwise agree; and
(b)	the Purchaser shall pay the Supplier any monies due the Supplier.

2.32 Governing Language

The Contract shall be written in English language which shall govern its interpretation. All correspondence and other documents pertaining to the Contract, which are exchanged by the parties, shall be written in the English language only.

2.33 Applicable Law / Jurisdiction

The Contract shall be interpreted in accordance with the laws of the Union of India and all disputes shall be subject to place of jurisdiction as specified in SCC.

2.34 Notices

- 2.34.1. Any notice given by one party to the other pursuant to this contract / order shall be sent to the other party in writing or by cable, telex, FAX, e-mail or / and confirmed in writing to the other party's address specified in the SCC.
- 2.34.2. A notice shall be effective when delivered or on the notice's effective date, whichever is later.

2.35 Taxes and Duties

- 2.35.1. For goods manufactured outside India, the Supplier shall be entirely responsible for all taxes, stamp duties, license fees, and other such levies imposed outside India.
- 2.35.2. For goods Manufactured within India, the Supplier shall be entirely responsible for all taxes, duties, license fees, etc., incurred till its final manufacture / production.
- 2.35.3. If any tax exemptions, reductions, allowances or privileges may be available to the Supplier in India, the Purchaser shall make its best efforts to enable the Supplier to benefit from any such tax savings to the maximum allowable extent.
- 2.35.4. All payments due under the contract shall be paid after deduction of statutory levies (at source) (like ESIC, IT, etc.) wherever applicable.
- 2.35.5. IITM is exempted from paying LBT & hence supplier supplying from outside Pune Municipal limits should quote prices excluding LBT.

2.36 Right to use Defective Goods

If after delivery, installation and within commissioning & acceptance and within warranty period, the operation or use of the goods proves to be unsatisfactory, the Purchaser shall have the right to continue to operate or use such goods until rectifications of defects, errors or omissions by repair or by partial or complete replacement is made without interfering with the Purchaser's operation.

2.37 Protection against Damage

The system shall not be prone to damage during power failures and trip outs. The normal voltage and frequency conditions available at site as under:

- (a) Voltage 230 volts – Single phase or 415 Volt for 3 phase ($\pm 10\%$)
- (b) Frequency 50 Hz.

2.38 Site preparation and installation

The Purchaser is solely responsible for the construction of the equipment sites unless otherwise specified in Chapter 4 in compliance with the technical and environmental specifications defined by the Supplier. The Purchaser will designate the installation sites before the scheduled installation date to allow the Supplier to perform a site inspection to verify the appropriateness of the sites before the installation of the Equipment, if required. The supplier shall inform the purchaser about the site preparation, if any, needed for installation, of the goods at the purchaser's site immediately after notification of award / contract.

2.39 Integrity Pact

- 2.39.1. As per directive of the CVC all organizations including IITM have to adopt an Integrity pact (IP) to ensure transparency, equity and competitiveness in major Public procurement having procurement value above Rs.5 Crore. The integrity pact envisages an agreement between the prospective bidders / vendors with the buyer committing the persons / officials of both the parties with the aim not to exercise any corrupt influence on any aspect of the contract. Only those bidders / vendors, who are willing to enter in to such an integrity pact with the Purchaser, would be competent to participate in the bidding.
- 2.39.2. IP also envisages Panel of Independent External Monitors (IEMs) which shall be provided / recommended by MoES and institutes with the approval of by CVC.

- 2.39.3. The integrity Pact would be effective from the date of invitation of bids till complete execution of the contract.
- 2.39.4. **The SCC shall specify whether there is a need to enter into a separate integrity pact or not.** If the Integrity Pact is required for the Tender then the format of Integrity Pact is as given in **Chapter – 8**.

CHAPTER 2

SPECIAL CONDITIONS OF CONTRACT (SCC)

The following Special Conditions of Contract (SCC) shall supplement and / or amend the General Conditions of Contract (GCC). Whenever there is a conflict, the provisions herein shall prevail over those in the GCC.

GCC Clause	Special Condition of Contract (SCC)
GCC 2.1.1(m)	The Purchaser is: THE DIRECTOR INDIAN INSTITUTE OF TROPICAL METEOROLOGY Dr.HOMI BHABHA ROAD, PASHAN, PUNE-411 008 (MAHARASHTRA)- INDIA
GCC 2.1.1(n)	The Final Destination is: INDIAN INSTITUTE OF TROPICAL METEOROLOGY Dr.HOMI BHABHA ROAD, PASHAN, PUNE-411 008 (MAHARASHTRA)- INDIA
GCC 2.12.1	The amount of the Performance Security shall be 10% of the contract value , valid up to 60 days after the date of completion of contract obligations including warranty obligations.
GCC 2.14.2	The marking and documentation within and outside the packages shall be marked with proper paint / indelible ink. (a) Each package should have a packing list within it detailing the Part No.(s), description, quantity etc. (b) Outside each package, the Contract No., the name and address of the Purchaser and the Final destination should be indicated on all sides and top. (c) Each package should be marked as 1/x, 2/x, 3/x.....x/x, where “x” is the total No. of packages contained in the consignment. (d) All the sides and top of each package should carry an appropriate indication / label / stickers indicating the precautions to be taken while handling / storage.
GCC 2.15.3	(a) In case of supplies from within India, the mode of transportation shall be by Air / Rail / Road . (b) In case of supplies from abroad, the mode of transportation shall be by Air/Sea .
GCC 2.16.1	The Insurance shall be for an amount equal to 110% of the CIF or CIP value of the contract from “warehouse to warehouse (final destination)” on “all risk basis” including strikes, riots and civil commotion, in addition to storage policy for 60 days is advised so as to ensure the inspection by the Indian Agent at the time of opening the packages.
GCC 2.20 (c)	The period of validity of the Warranty shall be: The warranty shall remain valid for Twelve (12) months after the Goods, or any portion thereof as the case may be, have been delivered to and accepted at the final destination or for Eighteen (18) months after the date of shipment from the port or place of loading in the country of origin, whichever period concludes earlier.
GCC 2.21.1	The method and conditions of payment to be made to the Supplier under this Contract shall be as follows: A Payment for Goods supplied from abroad: Payment of foreign currency portion shall be made in currency of the Contract in the following manner: (a) On Shipment: Eighty (80%) percent of the Contract Price of the Goods shipped shall be paid through irrevocable letter of credit opened in favour of the Supplier in a bank in its country, upon submission of documents specified in GCC Clause 2.15. (b) On Acceptance: Ten (10%) percent of the Contract Price of Goods received shall be paid within thirty (30) days of receipt of the Goods and successful installation & commissioning upon submission of claim supported by the acceptance certificate issued by the Purchaser along with the Performance security , if any. (c) Ten (10%) percent of the Contract Price of Goods received, upon acceptance of Performance Security / Performance Bank Guarantee submitted by supplier. (d) The LC for 100% value of the contract shall be established after deducting the agency commission payable if any, to the Indian agent from the FOB / FCA value. (e) The LC will be confirmed at the suppliers cost, if requested specifically by the supplier.

		All bank charges abroad shall be to the account of the beneficiary i.e. supplier and all bank charges in India shall be to the account of the opener i.e. purchaser. If LC is requested to be extended/ reinstated for reasons not attributable to the purchaser, the charges thereof would be to the suppliers' account. Payment of local currency portion shall be made in Indian Rupees within thirty (30) days of presentation of claim supported by a certificate from the Purchaser declaring that the Goods have been delivered and that all other contracted Services have been performed.
	B	Payment for Goods and Services supplied from India:
		The payment shall be made in Indian Rupees, as follows:
	(a)	On shipment : Eighty (80%) percent of the Contract Price shall be paid on receipt of the Goods and upon submission of the documents specified in GCC Clause 2.15
	(b)	On Acceptance: The remaining Ten (10%) percent of the Contract value shall be paid to the Supplier within thirty (30) days after the date of the acceptance certificate issued by the Purchaser subject to submission of performance security, if any.
	(c)	Ten (10%) percent of the Contract Price of Goods received, upon acceptance of Performance Security / Performance Bank Guarantee.
	(d)	In case of supplies where installation & commissioning is not required payment will be made within 30 days from receipt of items by purchaser as per purchase order contract.
	(e)	E-Payment: All payments, IITM prefers to make Electronic Transfers (RTGS) / (NEFT)
		NOTE:
		➤ All payments due under the Contract shall be paid after deduction of statutory levies at source (like ESIC, Income Tax, etc.), wherever applicable.
GCC 2.26.1	(a)	As time is the essence of the contract, Delivery period mentioned in the Purchase Order should be strictly adhered to. Otherwise we will have to forfeit EMD/PS and also LD clause will be applicable /enforced
	(b)	If the supplier fails to Supply, Install and Commission the system as per specifications mentioned in the order within the due date, the Supplier is liable to pay liquidated damages of 1% of order value per week of delay subject to a maximum of 10% beyond the due date. Such money will be deducted from any amount due or which may become due to the supplier
	(c)	IITM reserves the right to cancel the order in case the delay is more than 10 weeks. Penalties, if any, will be deducted from the EMD/PS
	(d)	The maximum amount of penalty shall be 10% .
	(e)	The liquidated damages shall be levied on the delivered price of the delayed Goods or unperformed Services or contract value.
GCC 2.33.1		The place of Jurisdiction is Pune, India.
GCC 2.34.1		For notices, the Purchaser's address is THE DIRECTOR INDIAN INSTITUTE OF TROPICAL METEOROLOGY Dr.HOMI BHABHA ROAD, PASHAN, PUNE-411 008 (MAHARASHTRA)- INDIA Telephone # : 0091-20-25904200 Facsimile number : 0091-20- 2586-5142 E-mail address: psu.iitm@tropmet.res.in
GCC 2.39.4		The integrity pact is not to be signed. However, efforts must be made to realize the objectives & spirits thereof.

CHAPTER 3

(To be filled by the bidder and enclosed with the Technical Bid)

SCHEDULE OF REQUIREMENT

The Schedule of Requirement must clearly specify **the time frame required (Schedule) for delivery of goods and services to be completed** by the bidder (in reference to Scope of Supply given in Clause-4.2 of Chapter-4) if the Contract is awarded for the offer / proposal submitted by the bidder in response to this Tender.

A) Delivery Schedule:

Sr. No.	Brief Description of Goods and Services	Quantity & Unit	Delivery Schedule

Period of delivery shall start from : _____

B) Term of delivery / Delivery Term :

Goods from Abroad	
Goods from India	

C) Time frame required for conducting installation, commissioning of the equipment, acceptance test, training, etc. after the arrival of consignment or before dispatch of equipment:

Sr. No.	Activity	Time Frame
1	Site Preparation (if required)	
2	Installation & Commissioning	
3	Acceptance Test	
4	Training	
5		

Place : _____

Signature of the Bidder : _____

Date : _____

CHAPTER 4

SPECIFICATIONS AND ALLIED TECHNICAL DETAILS

4.1 Supply & Installation of Modular Furniture as per enclosed Technical Details & Specifications for IITM, Pune.

Technical Requirements and Specifications

(Please refer Appendix No. – 1, available on page no. 59 to 78 of tender documents)

Note: 1) Optional items mentioned in the quotation will not be considered for commercial evaluation

2) Items to be supplied from India should be quoted in Indian Currency only

4.2 Scope of Supply

Scope of Supply includes the following:

- (i) Supply of the equipment / system as specified in 4.1 above
- (ii) Installation & Commissioning
- (iii) On site comprehensive Warranty as specified in 4.5 (i) below
- (iv) Supply of Spare parts as specified in 4.1 above.

4.3 Inspection & Tests

4.3.1 General

- (i) The Supplier shall at its own expense and at no cost to the Purchaser carry out all such tests and/or inspections of the Goods and Related Services as are specified here. The Supplier shall at its own expense and at no cost to the IITM carry out all such tests and/or inspections of the Goods and Related Services as are specified in the chapter 4 or as discussed and agreed to during the course of finalization of contract.
 - a. The inspections and tests may be conducted on the premises of the Supplier or its subcontractor(s), at the point of delivery and/or at the Goods final destination. If conducted on the premises of the Supplier or its subcontractor(s), all reasonable facilities and assistance, including access to drawings and production data - shall be furnished to the inspectors at no charge to the IITM
- (ii) Whenever the Supplier is ready to carry out any such test and inspection, it shall give a reasonable advance notice, including the place and time, to the Purchaser. The Supplier shall obtain from any relevant third party or manufacturer any necessary permission or consent to enable the Purchaser or its designated representative to attend the test and/or inspection.
- (iii) The IITM or its representative shall have the right to inspect and/or to test the Goods to confirm their conformity to the Contract specifications at no extra cost to the IITM and what inspections and tests the IITM requires and where they are to be conducted. The IITM shall notify the Supplier in writing in a timely manner of the identity of any representatives retained for these purposes.
- (iv) Should any inspected or tested Goods fail to conform to the specifications, the purchaser may reject the goods and the Supplier shall either replace the rejected Goods or make alterations necessary to meet specification requirements free of cost to the Purchaser.
- (v) The Purchaser's right to inspect, test and, where necessary, reject the Goods after the Goods' arrival at final destination shall in no way be limited or waived by reason of the Goods having previously been inspected, tested and passed by the Purchaser or its representative prior to the Goods shipment.

- (vi) The Supplier shall provide the Purchaser with a report of the results of any such test and/or inspection.
- (vii) With a view to ensure that claims on insurance companies, if any, are lodged in time, the bidders and /or the Indian agent, if any, shall be responsible for follow up with their Principals for ascertaining the dispatch details and informing the same to the Purchaser and he shall also liaise with the Purchaser to ascertain the arrival of the consignment after customs clearance so that immediately thereafter in his presence the consignment could be opened and the insurance claim be lodged, if required, without any loss of time. Any delay on the part of the bidder/ Indian Agent would be viewed seriously and he shall be directly responsible for any loss sustained by the purchaser on the event of the delay.
- (viii) Before the goods and equipment are taken over by the Purchaser, the Supplier shall supply operation and maintenance Manuals together with Drawings of the goods and equipment built. These shall be in such details as will enable the Purchase to operate, maintain, adjust and repair all parts of the works as stated in the specifications.
- (ix) The Manuals and Drawings shall be in the ruling language (English) and in such form and numbers as stated in the Contract.
- (x) Unless and otherwise agreed, the goods and equipment shall not be considered to be completed for the purposes of taking over until such Manuals and Drawing have been supplied to the Purchaser.
- (xi) On successful completion of acceptability test, receipt of deliverables, etc and after the Purchaser is satisfied with the working of the equipment, the acceptance certificate signed by the Supplier and the representative of the Purchaser will be issued. The date on which such certificate is signed shall be deemed to be the date of successful commissioning of the equipment. Acceptance certificate form as given in Annexure-I (Chapter 8) should be signed by authorised representative of Supplier & Purchaser.
- (xii) Installation demonstration is to be arranged by the supplier and the same is to be done within 15 days of the arrival of the equipment at site.

4.3.2 Manufacturer's Inspection Certificate

After the goods are manufactured and assembled, inspection and testing of the goods shall be carried out at the supplier's plant by the supplier, prior to shipment to check whether the goods are in conformity with the technical specifications. Manufacturer's test certificate with data sheet shall be issued to this effect and submitted along with the delivery documents. The purchaser reserves the options to be present at the supplier's premises during such Pre-dispatch inspection and testing.

4.3.3 Installation, Commissioning & Acceptance Test

The acceptance test will be conducted by the Purchaser, their consultant or other such person nominated by the Purchaser at its option after the equipment is installed at Purchaser's site in the presence of supplier's representatives. The acceptance will involve trouble free operation. There shall not be any additional charges for carrying out acceptance test. No malfunction, partial or complete failure of any part of the equipment is expected to occur. The Supplier shall maintain necessary log in respect of the result of the test to establish to the entire satisfaction of the Purchaser, the successful completion of the test specified.

In the event of the ordered item failing to pass the acceptance test, a period not exceeding two weeks will be given to rectify the defects and clear the acceptance test, failing which, the Purchaser reserve the right to get the equipment replaced by the Supplier at no extra cost to the Purchaser.

Successful conduct and conclusion of the acceptance test for the installed goods and equipment shall also be the responsibility and at the cost of the Supplier.

4.4 Training

- ~~(i) Location: IITM~~
- ~~(ii) Number of persons: For a group of students / technical staff~~
- ~~(iii) Period of Training: 5 working days after installation~~
- ~~(iv) Nature of training: To operate the equipment efficiently, training to collection & processing of the data, structure solution & refinement, safe handling of the equipment and minimum maintenance.~~

4.5 Incidental Services

(i) **On site Comprehensive Warranty:**

- The system excluding X-ray source and detector should be warranted for a period of 1 year (comprehensive warranty) from the date of installation whereas the warranty for the X-ray source and detector should be for a period of 5 years.
- Down-time call attendance should be within 24 hrs.
- In case the Equipment / System remains non-operational for more than 7 days then warranty period will be extended for the equivalent period for which Equipment / System remained non-operational. Warranty extension in such case shall be done without prejudice to any other Term & condition of the contract

(ii) **Annual Maintenance Contract (AMC):**

- ~~• Non-comprehensive AMC for five years after expiry of warranty may be quoted separately.~~
- ~~• Regularly scheduled tower inspection (or when and if required by the indenter for technical persons to climb the tower for maintenance work) and preventative maintenance including anti-rust painting, costs should be quoted separately for further five years from the date of tower installation. This is for assuring site reliability and safety of personnel working at the tower site.~~

4.6 Delivery Schedule

4-6 weeks After Receipt of Order

4.7 Commercial evaluation of bid

The bid will be treated as **incomplete** if bidder has **not quoted** for all the components given in scope of supply (clause 4.2) and **the incomplete bid will be rejected**. The bidder should also quote for all incidental services (clause 4.5). The bid will be commercially evaluated for the components in the scope of supply.

CHAPTER 5

Qualification Requirements

The Bidder shall furnish documentary evidence along with Technical Bid to support the following Qualification Criteria:

1) The bidder shall furnish documentary evidence to demonstrate that the bidder satisfies the bidders' **eligibility criteria**, as mentioned in **ITB Clause 1.1.2** in the form as per **Annexure-K of Chapter- 8**.

2) **Financial Qualifying Criteria:**

The Bidder shall furnish documentary evidence to meet the following Financial Qualifying Criteria:

a) An **undertaking (self-certificate)** is to be submitted that the Organization has not been blacklisted during last 3 years by any Central / State Government Department/Organization in the form as per **Annexure-L of Chapter- 8**.

b) The Creditworthy report - **MIRA inform report** of the **OEM / Principal** supplier for the Current Financial Year is to be enclosed along with the Technical Bid **if the total price of the Equipment/System is more than Rs. 1 crore (Rs.10 million)**. The minimum rating for Financial Qualification is **Rating-Ba**.

The Creditworthy Report may be obtained from:

M/s. MIRA INFORM PRIVATE LIMITED,
605, Palmspring, Near D'Mart,
Link Road, Malad (West),
Mumbai: 400 064;
Tel Nos.: 022 – 40448000 (44 lines)
Fax No. 022-0448045 / 40448046;
E-mail: mira@mirainform.com; info@mirainform.com
Website: <http://www.mirainform.com>

Note: The creditworthy report from other reputed and equivalent firms (such as Dun & Bradstreet) is also acceptable. However, report should have been obtained after **1st April 2017**.

3) The Bidder should be a manufacturer /authorized representative of a manufacturer who must have designed, manufactured, tested and supplied the equipment(s) similar to the type specified in the "Technical Specification". The **Manufacturers' Authorization Form** Chapter-8: Annexure B must be enclosed with the technical bid.

4) **Experience and Technical Capacity:**

The Bidder shall furnish documentary evidence to demonstrate that it meets the following experience requirement(s):

a) Equipment / System offered must be of the most recent series/models incorporating the latest improvements in design. The models should be in successful operation for at least one year as on date of Bid Opening.

b) The bidder (OEM/Direct Distributor/Dealer) should have supplied and installed during **past 3 years, at least two similar equipments / systems** as mentioned in Chapter-4. The Bidder should furnish the information on all past supplies and satisfactory performance during past 3 years in the **Performance Statement Form** (Chapter-8, Annexure D). Bidders shall invariably furnish documentary evidence (Client's certificate) in support of the **satisfactory operation of the equipment / system**.

c) Details of Service Centres and information on service support facilities that would be provided after the warranty period (in the **Service Support Form- Chapter-8 Annexure-F**).

- d) That adequate and specialized expertise is already available **or** will be made available following the execution of the contract in the Purchaser's country, to ensure that **the support services are responsive and adequate** as per **ITB 1.13.2(c)**.
- 5) The Indian Agents of foreign manufacturers/ suppliers quoting directly on behalf of their principals for items appearing in the **restricted list of the current EXIM policy of the Govt. of India** must be registered with DGS&D.
- 6) Either the Indian Agent on behalf of the foreign principal or the foreign principal directly could bid in a tender **but not both**. However, the offer of the Indian Agent should also accompany the authorization letter from their principal. Further, to maintain sanctity of tendering system **one Indian agent cannot represent two different foreign principals in one tender**.

The bidders who do not fulfil the above Eligibility, Financial and Technical Qualification Criteria shall be rejected during the Evaluation of Technical Bid.

CHAPTER 6:- PRICE SCHEDULE

Sr. No.	Item Description	Foreign Currency Component as per Chapter 6-A	INR Price Component as per Chapter 6-B
		A	B
01	Total Cost of (Supply, Installation & Commissioning Charges, Warranty Charges if any, Applicable Duties & Taxes etc.). The details may be submitted as per the pro-forma given at Chapter 6-A & 6-B accordingly)		
02	Grand Total		

Note : The prices mentioned at Sr. No. 02 should exactly be submitted at e-procurement website (Price Bid) and soft copies of price schedule along with relevant chapter 6A & 6B have to be uploaded on e-procurement web portal. The prices submitted on e-procurement website will treated as final and comparison will based on the said prices only.

CHAPTER 6- A:PRICE SCHEDULE FOR GOODS BEING OFFERED FROM ABROAD

(Bidder should quote in this format however, if quoted in different format; all parameters given below should be covered)

Tender No: _____ Tender Date: _____
 Quotation No. _____ Date: _____ Quotation Valid Upto: _____

Country of Origin: _____				Currency: _____		
Sr.No.	Description of Item		Quantity	Unit	Rate	Amount
	Catalogue, Part/Model No.	Specifications				
1.	Item name					
2.	Required Spares/Consumables (if any)					
3.	Accessories (if any)					
4.	Additional Items					
Total Ex-Works Price						
(-) LESS: Discount ___% (if any)						
Net Ex-Works Price						
(+) Packing & Forwarding Charges						
(+) Inland Freight Charges						
(INCO TERM): FOB / FCA _____ International Airport, _____ Country						
(+) Freight upto Mumbai & Insurance Charges						
CIF / CIP MUMBAI Price						
Approximate Weight of the Consignment			Approximate Dimensions of the Consignment			

TENDER CLAUSE NO.	TERM	CONDITION	
GCC/SCC 2.15.3	Mode of Shipment	BY AIR / SEA / ROAD	
GCC 2.15.2	Delivery Term(INCOTERM)		
CHAPTER 3	Delivery Schedule	As enclosed in Technical Bid as per Chapter-3	
	Period of delivery shall count from		
	Time Frame required for conducting Installation & commissioning of the equipment, Acceptance Test, Training, etc.		
	Port of destination	Mumbai, India	
	Final Destination	IITM, Pune	
	Installation & Commissioning Charges		
4.4	Training Details & Charges		
GCC/SCC 2.20 (c)	Warranty	Period	Charges if any
Annual Maintenance Contract	Comprehensive		
	Non-Comprehensive		
GCC/SCC 2.21.1	Payment Term		
GCC/SCC 2.21.1 (d)	Bank Charges	Inside India to IITM account and Outside India to beneficiary's account	

SIGNATURE OF AUTHORISED PERSON

CHAPTER 6- B :PRICE SCHEDULE FOR GOODS BEING OFFERED FROM INDIA

(Bidder should quote in this format however, if quoted in different format; all parameters given below should be covered)

Tender No: _____ Tender Date: _____
 Quotation No. _____ Date: _____ Quotation Valid Upto: _____

Sr.No.	Description of Item		Quantity	Unit	Rate	Amount (Rs.)
	Catalogue, Part/Model No.	Specifications				
1.	Item name					
2.	Required Spares/Consumables (if any)					
3.	Accessories (if any)					
4.	Additional Items					
Total Ex-Works Price						
(-) LESS: Discount ___% (if any)						
Net Ex-Works Price						
(+) Packing & Forwarding Charges						
(+) Transportation Charges						
(IITM is not exempted for GST) GST Charges						
SUB TOTAL						
Local Body Tax: IITM is exempted vide PMC Reg.No. LBT-005-0064836 for supplies from outside Pune Municipal Corporation Limits						
GRAND TOTAL						
Approximate Weight of the Consignment			Approximate Dimensions of the Consignment			

TENDER CLAUSE NO.	TERM		CONDITION	
GCC/SCC 2.15.3	Mode of Shipment		BY AIR / RAIL / ROAD	
GCC 2.15.2	Delivery Term		Free Delivery to IITM Pune	
CHAPTER 3	Delivery Schedule		As enclosed in Technical Bid as per Chapter-3	
	Period of delivery shall count from			
	Time Frame required for conducting Installation & commissioning of the equipment, Acceptance Test, Training, etc.			
	Port of destination		Mumbai, India	
	Final Destination		IITM, Pune	
	Installation & Commissioning Charges including taxes			
4.4	Training Details & Charges			
GCC/SCC 2.20.3	Warranty		Period	Charges if any
	Annual Maintenance Contract	Comprehensive		
		Non-Comprehensive		
GCC/SCC 2.21.1	Payment Term			

SIGNATURE OF AUTHORISED PERSON

BOQ for Supply and Installation of Modular Furniture with pre-laminated particle board & 2mm thick pvc edgeband finish including necessary fitting fixtures etc. for IITM, Pashan, Pune.

ITEM NO.	Description	Unit	Qty	Unit Rate (Supply Items)	Unit Rate (Installation Charges)	Basic Cost (Supply Items)	Basic Cost (Installation Charges)	Total Basic Cost (in ₹)
			A	B	C	D	E	F
						D = (A x B)	E = (A x C)	F = D + E
1	Office Table							
1.1	Size - 1650 x 750 x 750 mm Ht							
	Supply & Installation of Modular Office Table made out of pre-laminated particle board - Top 25mm thick with 2mm thk PVC edge band finish. Gable end & Modesty 18 mm thk with 2mm thk PVC edge band finish, 63mm dia grommet for cable and computer key board sliding tray , Complete with All necessary hardware & Fixture. [Note:1.For detailed information refer enclosed drawings. 2.Technical specifications,quantity and rates for Computer key board sliding tray have been considered sseparately under item no. 07.]	Nos.	4					
1.2	Size - 1500 x 750 x 750 mm Ht							
	Supply & Installation of Modular Office Table made out of pre-laminated particle board - Top 25mm thick with 2mm thk PVC edge band finish. Gable end & Modesty 18 mm thk with 2mm thk PVC edge band finish, 63mm dia grommet for cable and computer key board sliding tray , Complete with All necessary hardware & Fixture. [Note:1.For detailed information refer enclosed drawings. 2.Technical specifications,quantity and rates for Computer key board sliding tray have been considered sseparately under item no. 07.]	Nos.	27					
2	3 Dr Pedestal							
2.1	Size - 400 x 450 x 710 mm Ht							
	Supply & Installation of Modular Pedestal made out of pre-laminated particle board - complete unit made out of 18 mm thick PLPB with 2mm thk PVC edge band finish with all necessary hardware & Fixture.[Note:1.For detailed information refer enclosed drawings.]	Nos.	31					
3	Side Credenza							
3.1	Size - 900 x 450 x 750 mm Ht							
	Supply & Installation of Storage made out of pre-laminated particle board - complete unit made out of 18 mm thick PLPB with 2mm thk PVC edge band finish and all necessary hardware & Fixture. [Note: For detailed information refer enclosed drawings]	Nos.	31					
4	Full Ht Storage							
4.1	Size - 1800 x 418 x 2400 mm Ht							
	Supply & Installation of Modular Storage made out of pre-laminated particle board - complete unit made out of 18 mm thick PLPB with 2mm thk PVC edge band finish and all necessary hardware & Fixture. [Note: For detailed information refer enclosed drawings]	Nos.	27					
4.2	Approx. Size 4950x450x2400mm							
	Supply & Installation of Modular Storage for DISPACH SECTION made out of pre-laminated particle board - complete unit made out of 18 mm thick PLPB with 2mm thk PVC edge band finish and all necessary hardware & Fixture. [Note: For detailed information refer enclosed drawings]	Nos.	1					
5	Computer key board sliding tray							
5.1	Supply and Installation of Keyboard Drawer (Metal) 19" in Table to be fixed in office table.	Nos.	31					
6	Repro Table							
6.1	Supply and Installation of repro table made out of pre-laminated Prticle board with 2mm thk PVC edge band finish and all necessary hardware & Fixture. [Note: For detailed information refer enclosed drawings]	Nos.	2					
	TOTAL BASIC COST - (I)							
	GST ON SUPPLY ITEMS (WITH HSN CODE) - II							
	GST ON INSTALLATION CHARGES (WITH HSN CODE) - III							
	TOTAL COST (I + II + III)							

CHAPTER 7

Contract Form

Contract No. _____ Date: _____

THIS CONTRACT AGREEMENT is made
the [*insert: number*] day of [*insert: month*], [*insert: year*].

BETWEEN

- (1) Indian Institute of Tropical Meteorology registered under the Societies Registration Act 1860 of the Government of India having its registered office at Dr. Homi Bhabha Road, Pashan, Pune – 411 008, India (hereinafter called “the Purchaser”), and
- (2) [*insert name of Supplier*], a corporation incorporated under the laws of [*insert: country of Supplier*] and having its principal place of business at [*insert: address of Supplier*] (hereinafter called “the Supplier”).

WHEREAS the Purchaser invited bids for certain Goods and ancillary services, viz., [*insert brief description of Goods and Services*] and has accepted a Bid by the Supplier for the supply of those Goods and Services in the sum of [*insert Contract Price in words and figures, expressed in the Contract currency(ies)*] (hereinafter called “the Contract Price”).

NOW THIS AGREEMENT WITNESSETH AS FOLLOWS:

01. In this Agreement words and expressions shall have the same meanings as are respectively assigned to them in the Conditions of Contract referred to.
02. The following documents shall constitute the Contract between the Purchaser and the Supplier, and each shall be read and construed as an integral part of the Contract:

(a)	This Contract Agreement
(b)	General Conditions of Contract
(c)	Special Conditions of Contract
(d)	Technical Requirements (including Schedule of Requirements and Technical Specifications)
(e)	The Supplier’s Bid and original Price Schedules
(f)	The Purchaser’s Notification of Award
(g)	[<i>Add here any other document(s)</i>]

03. This Contract shall prevail over all other Contract documents. In the event of any discrepancy or inconsistency within the Contract documents, then the documents shall prevail in the order listed above.
04. In consideration of the payments to be made by the Purchaser to the Supplier as hereinafter mentioned, the Supplier hereby covenants with the Purchaser to provide the Goods and Services and to remedy defects therein in conformity in all respects with the provisions of the Contract.
05. The Purchaser hereby covenants to pay the Supplier in consideration of the provision of the Goods and Services and the remedying of defects therein, the Contract Price or such other sum as may become payable under the provisions of the Contract at the times and in the manner prescribed by the Contract.

IN WITNESS whereof the parties hereto have caused this Agreement to be executed in accordance with the laws of Union of India on the day, month and year indicated above.

For and on behalf of the IITM, Pune.

Signed : [*insert signature*]
in the capacity of [*insert title or other appropriate designation*]
in the presence of [*insert identification of official witness*]

Signed : [*insert signature*]
in the capacity of [*insert title or other appropriate designation*]
in the presence of [*insert identification of official witness*]

For and on behalf of the Supplier

Signed : [*insert signature of authorized representative(s) of the Supplier*]
in the capacity of [*insert title or other appropriate designation*]
in the presence of [*insert identification of official witness*]

CHAPTER 8

OTHER STANDARD FORMS

Sr. No.	Name of the Form	Annexure
1	Bidder Information Form	A
2	Manufacturers' Authorization Form	B
3	Bid Security Form / Earnest Money Deposit	C
4	Performance Statement Form	D
5	Deviation Statement Form	E
6	Service Support Detail Form	F
7	Bid Form	G
8	Performance Security Form	H
9	Acceptance Certificate Form	I
10	Indemnity Bond	J
11	Eligibility Certificate	K
12	Non Black List Certificate	L

NOTE: The Successful Bidder shall submit Documents with reference to Annexure – H, I & J after Award of Contract as mentioned in Purchase Order.

Bidder Information Form

- (a) [The Bidder shall fill in this Form in accordance with the instructions indicated below. No alterations to its format shall be permitted and no substitutions shall be accepted. This should be done of the letter head of the firm]

Date : [Insert date (as day, month and year) of Bid Submission]

Tender No : [Insert number from Invitation for bids]

01.	Bidder's Legal Name [Insert Bidder's legal name]
02.	In case of JV, legal name of each party: [Insert legal name of each party in JV]
03.	Bidder's actual or intended Country of Registration: [Insert actual or Intended Country of Registration]
04.	Bidder's Year of Registration: [Insert Bidder's year of registration]
05.	Bidder's Legal Address in Country of Registration: [Insert Bidder's legal address in country of registration]
06.	<p>Bidder's Authorized Representative Information</p> <p>Name: [Insert Authorized Representative's name]</p> <p>Address: [Insert Authorized Representative's Address]</p> <p>Telephone/Fax numbers: [Insert Authorized Representative's telephone/fax numbers]</p> <p>Email Address: [Insert Authorized Representative's email address]</p>
07.	<p>Attached are copies of original documents of:</p> <p>Articles of Incorporation or Registration of firm named in 1, above.</p>

Signature of Bidder _____

Name _____

Business Address _____

MANUFACTURERS' AUTHORIZATION FORM

[The Bidder shall require the Manufacturer to fill in this Form in accordance with the instructions indicated. This letter of authorization should be on the letterhead of the Manufacturer and should be signed by a person with the proper authority to sign documents that are binding on the Manufacturer.]

Date : *[Insert date (as day, month and year) of Bid Submission]*

Tender No. : *[Insert number from Invitation For Bids]*

To : *[Insert complete name and address of Purchaser]*

WHEREAS

We *[insert complete name of Manufacturer]*, who are official manufacturers of *[insert type of goods manufactured]*, having factories at *[insert full address of Manufacturer's factories]*, do hereby authorize *[insert complete name of Bidder]* to submit a bid the purpose of which is to provide the following Goods, manufactured by us *[insert name and or brief description of the Goods]*, and to subsequently negotiate and sign the Contract.

We hereby extend our full guarantee and warranty in accordance with Clause 2.20 of the General Conditions of Contract, with respect to the Goods offered by the above firm.

Signed: *[insert signature(s) of authorized representative(s) of the Manufacturer]*

Name: *[insert complete name(s) of authorized representative(s) of the Manufacturer]*

Title: *[insert title]*

Duly authorized to sign this Authorization on behalf of: *[insert complete name of Bidder]*

Dated on _____ day of _____, _____ *[insert date of signing]*

BID SECURITY FORM

Whereas _____
(hereinafter called the tenderer)

has submitted their offer dated _____
for the supply of _____
(hereinafter called the tender)

Against the Purchaser's Tender No. _____
KNOW ALL MEN by these presents that WE _____
of _____ having our registered office at
_____ are bound unto _____ (hereinafter called the "Purchaser")

In _____ the _____ sum _____ of _____

For which payment will and truly to be made to the said Purchaser, the Bank binds itself, its successors and assigns by these presents. Sealed with the Common Seal of the said Bank this _____ day of _____ 20____.

THE CONDITIONS OF THIS OBLIGATION ARE:

(1)	If the tenderer withdraws or amends or modifies or impairs or derogates from the Tender in any respect within the period of validity of this tender.
(2)	If the tenderer having been notified of the acceptance of his tender by the Purchaser during the period of its validity
(3)	If the tenderer fails to furnish the Performance Security for the due _____ Performance of the contract.
(4)	Fails or refuses to accept/execute the contract.

We undertake to pay the Purchaser up to the above amount upon receipt of its first written demand, without the Purchaser having to substantiate its demand, provided that in its demand the Purchaser will note that the amount claimed by it is due to it owing to the occurrence of one or both the two conditions, specifying the occurred condition or conditions.

This guarantee will remain in force up to and including 45 days after the period of tender validity and any demand in respect thereof should reach the Bank not later than the above date.

(Signature of the authorized officer of the Bank)

Name and designation of the officer
Seal, name & address of the Bank and address of the

Branch

Note: Whenever the bidder chooses to submit the Bid Security in the form of Bank Guarantee, then he should advise the banker issuing the Bank Guarantee to immediately send by Registered Post (A.D.) an unstamped duplicate copy of the Guarantee directly to the Purchaser with a covering letter to compare with the original BG for the correctness, genuineness, etc.

PERFORMANCE STATEMENT FORM

Details of similar equipment / systems supplied & installed during past 3 years in India & Abroad

Name of the Firm _____

Order Placed by (full address of Purchaser)	Order No. and date	Description and quantity of ordered equipment	Value of order	Date of completion of deliver as per contract	Date of actual completion of delivery	Remarks indicating reasons for late delivery, if any	Has the equipment been installed/ working satisfactory? (Attach a certificate from the purchaser / Consignee)	Name of Contact person along with Telephone No., FAX No. and e-mail address

Signature and Seal of the manufacturer/Bidder

Place :

Date :

DEVIATION STATEMENT FORM

PART -I

The following are the particulars of deviations from the requirements of the tender specifications:

CLAUSE	DEVIATION	REMARKS (INCLUDING JUSTIFICATION)

Place:

Date:

**Signature and seal of the
Manufacturer/Bidder**

NOTE:

Where there is no deviation, the statement should be returned duly signed with an endorsement indicating "No Deviations".

PART – II
(Refer Clause 1.25 of Tender Document)

Sr.No.	TENDER REQUIREMENT	COMPLIANCE	Document Submitted
1	Bid is Signed	Yes / No	Yes / NA
2	This is to certify that we are eligible to bid for this tender as per Annexure-C	Yes / No	Yes / NA
3	Bid Validity (90 days after the date of Bid opening)	Yes / No Bid valid up to	Yes / NA
4	Warranty: As per Clause 13 of Tender Document from Installation & Commissioning and date of acceptance.	Yes / No	Yes / NA
5	Agree to submit Performance Security 10% of PO Value as per Clause 17(ii)	Yes / No	Yes / NA
6	Bidder Information Form enclosed as per Annexure –A	Yes / No	Yes / NA
7	Manufacturers Authorisation Form (MAF) (If Applicable), Annexure-B	Yes / No	Yes / NA
8	Certification of non-black listing (Self Certification) as per Annexure-D	Yes / No	Yes / NA
9	Performance Statement Form enclosed as per Annexure F	Yes / No	Yes / NA
10	Service Support details enclosed as per Annexure E	Yes / No	Yes / NA

The Bidder should **submit other documents** such as fulfilment of financial qualification criteria (MIRA Inform Report), Schedule of Requirement (Chapter-3) and various forms as specified in Chapter-8.

SERVICE SUPPORT DETAIL FORM

Sr. No.	List of similar type of equipments serviced in the past 3 years	Address, Telephone Nos., Fax No. and e-mail address of the buyer	Nature of training Imparted/ service provided	Name and address of service provider

Signature and Seal of the manufacturer/Bidder.....

Place :

Date :

Bid Form

[The Bidder shall fill in this Form in accordance with the instructions indicated No alterations to its format shall be permitted and no substitutions shall be accepted.]

Date : *[Insert date (as day, month and year) of Bid Submission]*

Tender No. :

To : Director, IITM, Pune

We, the undersigned, declare that:

(a)	We have examined and have no reservations to the Bidding Documents, including Addenda No.: <i>[Insert the number and issuing date of each Addenda]</i>
(b)	We offer to supply in conformity with the Bidding Documents and in accordance with the Delivery Schedules specified in the Schedule of Requirements the following Goods and Related Services <i>[Insert a brief description of the Goods and Related Services]</i> as specified in Chapter 4
(c)	The total price of our Bid, excluding any discounts offered in item (d) below, is: <i>[Insert the total bid price in words and figures, indicating the various amounts and the respective currencies]</i>
(d)	The discounts offered and the methodologies for their application are: Discounts. If our bid is accepted, the following discounts shall apply. <i>[Specify in detail each discount offered and the specific item of the Schedule of Requirements to which it applies.]</i>
(e)	Our bid shall be valid for the period of time specified in ITB Clause 1.16, from the date fixed for the bid submission due date in accordance with ITB Clause 1.19 and it shall remain binding upon us and may be accepted at any time before the expiration of that period
(f)	If our bid is accepted, we commit to obtain a performance security in accordance with ITB Clause 1.41 and GCC Clause 2.12 for the due performance of the Contract
(g)	The following commissions, gratuities, or fees have been paid or are to be paid with respect to the bidding process or execution of the Contract: <i>[Insert complete name of each Recipient, its full address, the reason for which each commission or gratuity was paid and the amount and currency of each such commission or gratuity]</i>

Name of Recipient	Address	Reason	Amount
_____	_____	_____	_____
_____	_____	_____	_____
_____	_____	_____	_____

(If none has been paid or is to be paid, indicate “none.”)

(h)	We understand that this bid, together with your written acceptance thereof included in your notification of award, shall constitute a binding contract between us, until a formal contract is prepared and executed.
(i)	We understand that you are not bound to accept the lowest evaluated bid or any other bid that you may receive.

Signed : *[Insert signature of person whose name and capacity are shown]*

In the capacity of *[Insert legal capacity of person signing the Bid Submission Form]*

Name : *[Insert complete name of person signing the Bid Submission Form]*

Duly authorized to sign the bid for and on behalf of: *[Insert complete name of Bidder]*

Dated on _____ day of _____, _____ *[Insert date of signing]*

PERFORMANCE SECURITY FORM

MODEL BANK GUARANTEE FORMAT FOR PERFORMANCE SECURITY

To,
.....

WHEREAS
(name and address of the supplier) (hereinafter called “the supplier”) has undertaken, in pursuance of contract no. datedto supply (description of goods and services) (herein after called “the contract”).

AND WHEREAS it has been stipulated by you in the said contract that the supplier shall furnish you with a bank guarantee by a scheduled commercial bank recognized by you for the sum specified therein as security for compliance with its obligations in accordance with the contract;

AND WHEREAS we have agreed to give the supplier such a bank guarantee;

NOW THEREFORE we hereby affirm that we are guarantors and responsible to you, on behalf of the supplier, up to a total of (amount of the guarantee in words and figures), and we undertake to pay you, upon your first written demand declaring the supplier to be in default under the contract and without cavil or argument, any sum or sums within the limits of (amount of guarantee) as aforesaid, without your needing to prove or to show grounds or reasons for your demand or the sum specified therein.

We hereby waive the necessity of your demanding the said debt from the supplier before presenting us with the demand.

We further agree that no change or addition to or other modification of the terms of the contract to be performed there under or of any of the contract documents which may be made between you and the supplier shall in any way release us from any liability under this guarantee and we hereby waive notice of any such change, addition or modification.

This guarantee shall be valid until the day of, 20.....

(Signature of the authorized officer of the Bank)

.....
Name and designation of the officer

.....
Seal, name & address of the Bank and address of the Branch

Note: Whenever, the bidder chooses to submit the Performance Security in the form of Bank Guarantee, then he should advise the banker issuing the Bank Guarantee to immediately send by Registered Post (A.D.) an unstamped duplicate copy of the Guarantee directly to the Purchaser with a covering letter to compare with the original BG for the correctness, genuineness, etc.

Acceptance certificate form

No.

Dated:

M/s.

Sub: Certificate of commissioning of equipment

01. This is to certify that the equipment as detailed below has/have been received in good condition along with all the standard and special accessories (subject to remarks in Para 2). The same has been installed and commissioned.

(a)	Contract No. Date:	
(b)	Description of the equipment	
(c)	Name of the consignee	
(d)	Scheduled date of delivery of the consignment to the Laboratory / Institutes	
(e)	Actual date of receipt of consignment by the Laboratory / Institutes	
(f)	Scheduled date for completion of installation/commissioning	
(g)	Actual date of completion of installation/commissioning	
(h)	Penalty for late delivery (at Laboratory / Institutes level) Rs.	
(i)	Penalty for late installation (at Laboratory / Institutes level) Rs.	

02 Details of accessories/items not yet supplied and recoveries to be made on that account:

Sr. No.	Description	Amount to be recovered

03 The acceptance test has been done to our entire satisfaction. The supplier has fulfilled his contractual obligations satisfactorily

OR

The supplier has **failed to fulfil** his contractual obligations with regard to the following:

Sr. No.	Failure	Amount to be recovered
(a)		
(b)		
(c)		

The amount of recovery on account of failure of the supplier to meet his contractual obligations is as indicated at para03.

For Supplier

Signature

Name

Designation

Name of the firm

For Purchaser

Signature

Name

Designation

INDIAN INSTITUTE OF TROPICAL METEOROLOGY

Date

Date

INDEMNITY BOND

No. _____

Date:_____

1) Amalgamation/Acquisition

In the event of M/s. _____proposes for amalgamation, acquisition or sale of its business to any other firm during this contract period, M/s._____ and proposed Buyer/Successor of the Principal Company are liable to execute, fulfill contractual obligations without any deviations. For this purpose M/s. _____/M/s._____ and proposed Buyer/Successor of the Principal Company shall indemnify itself to the Director, INDIAN INSTITUTE OF TROPICAL METEOROLOGY , Pune to fulfill the contractual obligations as per the terms of the IITM Global Tender and quotation of M/s. _____-No. _____ dated_____and INDIAN INSTITUTE OF TROPICAL METEOROLOGY P.O. No._____dated _____ . The contractual obligations are supply, installation, commissioning, warranty maintenance/replacement of spares, accessories etc. as per the above mentioned Purchase Order.

2) Joint Venture, Consortium or Association

If the Supplier is a joint venture, consortium, or association, all the parties shall be jointly and severally liable to the IITM for the fulfillment of the provisions of the Contract and shall designate one party to act as a leader with authority to bind the joint venture, consortium, or association. The composition or the constitution of the joint venture, consortium, or association shall not be altered without the prior consent of the IITM.

3) Patent Indemnity

The Supplier shall, subject to IITM's compliance and indemnify and hold IITM and its employees and officers harmless from and against any and all suits, actions or administrative proceedings, claims, demands, losses, damages, costs, and expenses of any nature, including attorney's fees and expenses, which IITM may suffer as a result of any infringement or alleged infringement of any patent, utility model, registered design, trademark, copyright, or other intellectual property right registered or otherwise existing at the date of the Contract by reason of: (a) the installation of the Goods by the Supplier or the use of the Goods in India; and (b) the sale in any country of the products produced by the Goods.

For M/s. _____
Principal Supplier.

For M/s. _____
Indian Agent.

ANNEXURE-K

Eligibility Certificate

This is to certify that we are not associated, or have been associated in the past, directly or indirectly, with a firm or any of its affiliates which have been engaged by the Purchaser to provide consulting services for the preparation of the design, specifications, and other documents to be used for the procurement of the goods to be purchased under this Invitation of Bids / Tender No. _____ dated _____.

Authorised Signatory

Name: _____

Designation: _____

ANNEXURE-L

Non-Black listing Self Certificate

This is to certify that M/s. _____ has not been blacklisted by any Central / State Government Department / organization in last 3 years.

Authorised Signatory

Name: _____

Designation: _____

This is an E- Procurement event of IITM, Pune. The E-Procurement service provider is MSTC Ltd., 225C, A.J.C. Bose Road, Kolkata-700 020.

Bidders are requested to read the terms & conditions of this tender before submitting their online tenders. Bidders who do not comply with the conditions with documentary proof (wherever required) will not qualify in the Tender process for opening of Commercial bid.

Process of E-Tender :

A) Registration: The process involves Bidder’s registration with MSTC E- Procurement portal which is free of cost. Only after registration, the Bidder(s) can submit his/their bids electronically. Electronic Bidding for submission of Technical Bid as well as Commercial Bid will be done over the internet. The Bidder should possess Class III signing type digital certificate. Bidders have to make their own arrangement for bidding from a P.C. connected with Internet. MSTC is not responsible for making such arrangement. (Bids will not be recorded without Digital Signature).

SPECIAL NOTE: THE TECHNICAL BID, COMMERCIAL BID HAVE TO BE SUBMITTED ON-LINE AT

www.mstcecommerce.com/eprochome/iitm

- Bidders are required to register themselves online with www.mstcecommerce.com/eprochome/iitm/ -> Register as vendor -- Filling up details and creating own user id and password and submit the details.
- Bidders will receive a system generated mail confirming their registration in their email which has been provided during filling the registration form.

In case of any clarification, please contact IITM, Pune /MSTC, (before the scheduled time of the e- tender).

Contact person (IITM):

V. R. Mali

Scientific Officer Grade - II

Telephone No. : 020 25904483

Contact person (MSTC Ltd):

1. Shri Tejas V

Executive

Tel: 022 22882854 / +91-9535718617

2. Shri Ganesh Yadav

Sr. Manager

Tel. No.: 022 22022096 / +91-9869043055

e-mail: ganeshyadav@mstcindia.co.in

3. Smt. Lisbeth Dias

Sr. Manager

Tel No: 022 22883501 / +91-9820158988

email: lpaadickan@mstcindia.co.in

B) System Requirement:

System Requirements are indicated under **Vendor Guide** available on Login Page of Website:

www.mstcecommerce.com/eprochome/iitm

Latest version of Java software to be downloaded and installed in the system. Security level should be medium

To enable ALL active X controls and disable ‘use pop up blocker’ under Tools→Internet Options→ custom level (Please run IE settings from the page www.mstcecommerce.com once). **Prospective vendors are suggested to refer to “Vendor Guide” at**

www.mstcecommerce.com/eprochome/iitm.

- Part I Technical bid will be opened electronically on specified date and time as given in the NIT. Bidder(s) can witness electronic opening of bid.
- Part II Commercial bid will be opened electronically of only those bidder(s) whose Part-I Technical Bid is found to be acceptable by IITM, Pune. Such bidder(s) will be intimated date of opening of Part-II Commercial bid, through valid email confirmed by them.

- All entries in the tender should be entered in online Technical & Commercial Formats without any ambiguity.

C) Special Note towards Transaction fee: Transaction fee is to be paid by RTGS/NEFT to **MSTC Limited**. Vendor required to use link “Transaction Fee Payment” for generating. The detail procedure and to generate Challan for bank account details can be checked under **Vendor Guide** provided on Login Page of Website :

www.mstcecommerce.com/eprochome/iitm

OR

Vendor Guide Can be Downloaded from below URL:

<http://www.mstcecommerce.com/eprochome/Vendor-Guide-V5.pdf>

- **NOTE:** The bidders should submit the transaction fee ON OR BEFORE THE PRESCRIBED DATE as they will be authorized for bid submission only after receipt of transaction fee by MSTC.
- Click on Transaction Fee Payment -> Select event no from the drop down box -> Select NEFT/ RTGS or Online Payment.
On selecting NEFT, the vendor shall generate a challan by filling up a form. The vendor shall remit the transaction fee amount as per the details printed on the challan without making change in the same. ake the printout of the challan and make the payment. There shall be auto authorization of payment. Bidder shall be receiving a system generated mail.
- Bidders may please note that the transaction fee should be deposited by debiting the A/C of the bidder only; **transaction fee deposited from or by debiting any other party’s a/c will not be accepted. Transaction fee is non-refundable.**
- In case of failure to submit the payment towards Transaction fee for any reason, the Bidder, will not have the access to online E-Tender.

D)	All notices, /corrigendum and correspondence to the bidder(s) shall be sent by email only during the process till finalization of tender by IITM, Pune. Hence the bidders are required to ensure that their corporate email I.D. provided is valid and updated at the stage of registration of Bidder with MSTC (i.e. Service Provider). Bidders are also requested to ensure validity of their DSC (Digital Signature Certificate).
E)	E-Tender cannot be accessed after the due date and time mentioned in NIT.
F)	<p>Bidding in E-Tender:</p> <ul style="list-style-type: none"> Bidder(s) need to submit necessary Transaction fees to be eligible to bid online in the E-Tender. Transaction fees are non refundable. The process involves Electronic Bidding for submission of Technical and Commercial Bid The bidder(s) who have submitted the above fees can only submit their Technical Bid and Commercial Bid through internet in MSTC website www.mstcecommerce.com/eprochome/iitm/ → Vendor Login → My menu→ Auction Floor Manager→ live event →Selection of the live event The bidder should allow to run an application namely enApple by accepting the risk and clicking on run. This exercise has to be done twice immediately after opening of Bid floor. Then they have to fill up Common terms/Commercial specification and save the same. After that clicking on the Technical bid. If this application is not run then the bidder will not be able to save/submit his Technical bid. After filling the Technical Bid, bidder should click 'save' for recording their Technical bid. Once the same is done, the Commercial Bid link becomes active and the same has to filled up and then bidder should click on "save" to record their Commercial bid. Then once both the Technical bid & Commercial bid has been saved, the bidder can click on the "Final submission" button to register their bid Bidders are instructed to use 'Attach Docs' link to upload documents in document library. Multiple documents can be uploaded. Maximum size of single document for upload is 5 MB.
G)	In all cases, bidder should use their own ID and Password along with Digital Signature at the time of submission of their bid.
H)	During the entire E-Tender process, the bidders will remain completely anonymous to one another and also to everybody else.
I)	The E-Tender floor shall remain open from the pre-announced date & time and for as much duration as mentioned above.
J)	All electronic bids submitted during the E-Tender process shall be legally binding on the bidder. Any bid will be considered as the valid bid offered by that bidder and acceptance of the same by the Buyer will form a binding contract between Buyer and the Bidder for execution of supply.
K)	It is mandatory that all the bids are submitted with digital signature certificate otherwise the same will not be accepted by the system.
L)	Purchaser reserves the right to cancel or reject or accept or withdraw or extend the tender in full or part as the case may be without assigning any reason thereof.
M)	<p>Submission of bid in the E-Tender floor by any bidder confirms his acceptance of terms & conditions for the tender.</p> <ul style="list-style-type: none"> Unit of Measure (UOM) is indicated in the E-Tender. Rate to be quoted should be as per UOM indicated in the E-Tender floor.
	<ul style="list-style-type: none"> The Purchaser has the right to cancel this E-Tender or extend the due date of receipt of bid(s) without assigning any reason thereof.
	<ul style="list-style-type: none"> The online tender should be submitted strictly as per the terms and conditions and procedures laid down on website www.mstcecommerce.com/eprochome/iitm/ of MSTC Ltd.
	<ul style="list-style-type: none"> The bidders must upload all the documents required as per terms of NIT / Tender Document. Any other document uploaded which is not required as per the terms of the NIT / Tender Document shall not be considered. The bid will be evaluated based on the filled-in technical & commercial formats.
	<ul style="list-style-type: none"> The documents uploaded by bidder(s) will be scrutinized. In case any of the information furnished by the bidder is found to be false during scrutiny, appropriate punitive action / legal action can also be taken against defaulting bidders.
	<ul style="list-style-type: none"> Bidders are requested to read the Bidder guide and see the video in the page www.mstcecommerce.com/eprochome/iitm/ to familiarize them with the system before bidding.

TECHNICAL SPECIFICATIONS FOR MODULAR FURNITURE QTY – AS PER ENCLOSED.

Supply & Installation of Modular Furniture as per enclosed Technical Details & Specifications for Admin Wing at IITM, Pune.

MODULAR FURNITURE FOR ADMIN WING IITM PUNE SUMMARY SHEET								
SL. NO.	LOCATION	OFFICER TABLE OF SIZE 1650X750X750MM	STAFF TABLE OF SIZE 1500X750X750MM	3 DR PEDESTAL OF SIZE 400X450X710MM	SIDE CREDENZ A OF SIZE 900X450X750MM	FULL HEIGHT STORAGE OF SIZE 1800X418X2400MM	REPRO TABLE OF SIZE 600X600X750MM	Computer Key board tray for Officers and Staff table
1	F-120	2	0	2	2	4	0	2
2	F-122	1	4	5	5	4	1	5
3	F-128	0	4	4	4	4		4
4	F-130	0	1	1	1	0	0	1
5	F-132	0	3	3	3	2	0	3
6	F-134	0	3	3	3	2	0	3
	F-136	0	3	3	3	2	0	3
	F-129 & 131	0	4	4	4	4	0	4
	F-138	0	5	5	5	3	0	5
	F-133	1	0	1	1	2	1	1
	TOTAL	4	27	31	31	27	2	31

1. OFFICE TABLES

PROPOSED SIZE: 1650 X 750 X 750 MM and
1500 X 750 X 750 MM

ISOMETRIC IMAGE:



SPECIFICATION:

Supply & Installation of Modular Office Table made out of prelaminated particle board - Top 25mm thick with 2mm thk PVC edge band finish. Gable end & Modesty 18 mm thk with 2mm thk PVC edge band finish, 63mm dia grommet for cable and computer key board sliding tray , Complete with All necessary hardware & Fixture.

[Note: For detailed information refer enclosed drawings]

2. 3 Drawer Pedestal (Under table storage trolley):

PROPOSED SIZE: 400 X 450 X 710 MM

ISOMETRIC IMAGE:



SPECIFICATION: Supply & Installation of Modular Pedestal made out of prelaminated particle board - complete unit made out of 18 mm thick PLPB with 2mm thk PVC edge band finish with all necessary hardware & Fixture.

[Note: For detailed information refer enclosed drawings]

3. SIDE CREDENZA:

PROPOSED SIZE: 900 X 450 X 750 MM

ISOMETRIC IMAGE:

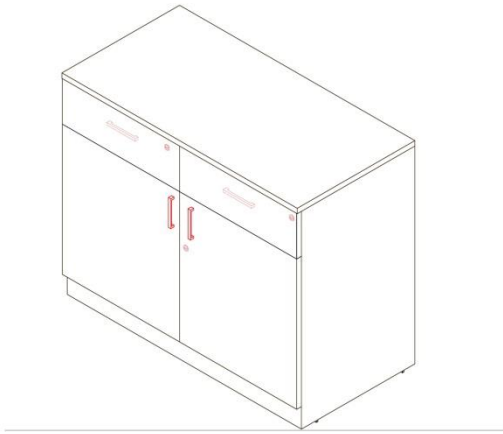

SPECIFICATION: Supply & Installation of Storage made out of prelaminated particle board - complete unit made out of 18 mm thick PLPB with 2mm thk PVC edge band finish and all necessary hardware & Fixture. [Note: For detailed information refer enclosed drawings]

4. FULL HT STORAGE:

PROPOSED SIZE: 900 X 450 X 750 MM

ISOMETRIC IMAGE:



SPECIFICATION: Supply & Installation of Modular Storage made out of prelaminated particle board - complete unit made out of 18 mm thick PLPB with 2mm thk PVC edge band finish and all necessary hardware & Fixture. [Note: For detailed information refer enclosed drawings]

5. FULL HT STORAGE PARTITION FOR DISPACH SECTION:

PROPOSED SIZE: 4500 X 450 X 2400MM

ISOMETRIC IMAGE:

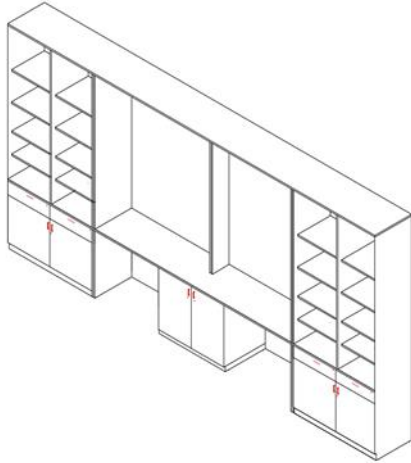

SPECIFICATION: Supply & Installation of Modular Storage made out of prelaminated particle board - complete unit made out of 18 mm thick PLPB with 2mm thk PVC edge band finish and all necessary hardware & Fixture.

[Note: For detailed information refer enclosed drawings]

- Sd -

**ASSISTANT MANAGER (PURCHASE SECTION)
IITM, PUNE - 411 008
E-mail : psu.iitm@tropmet.res.in**

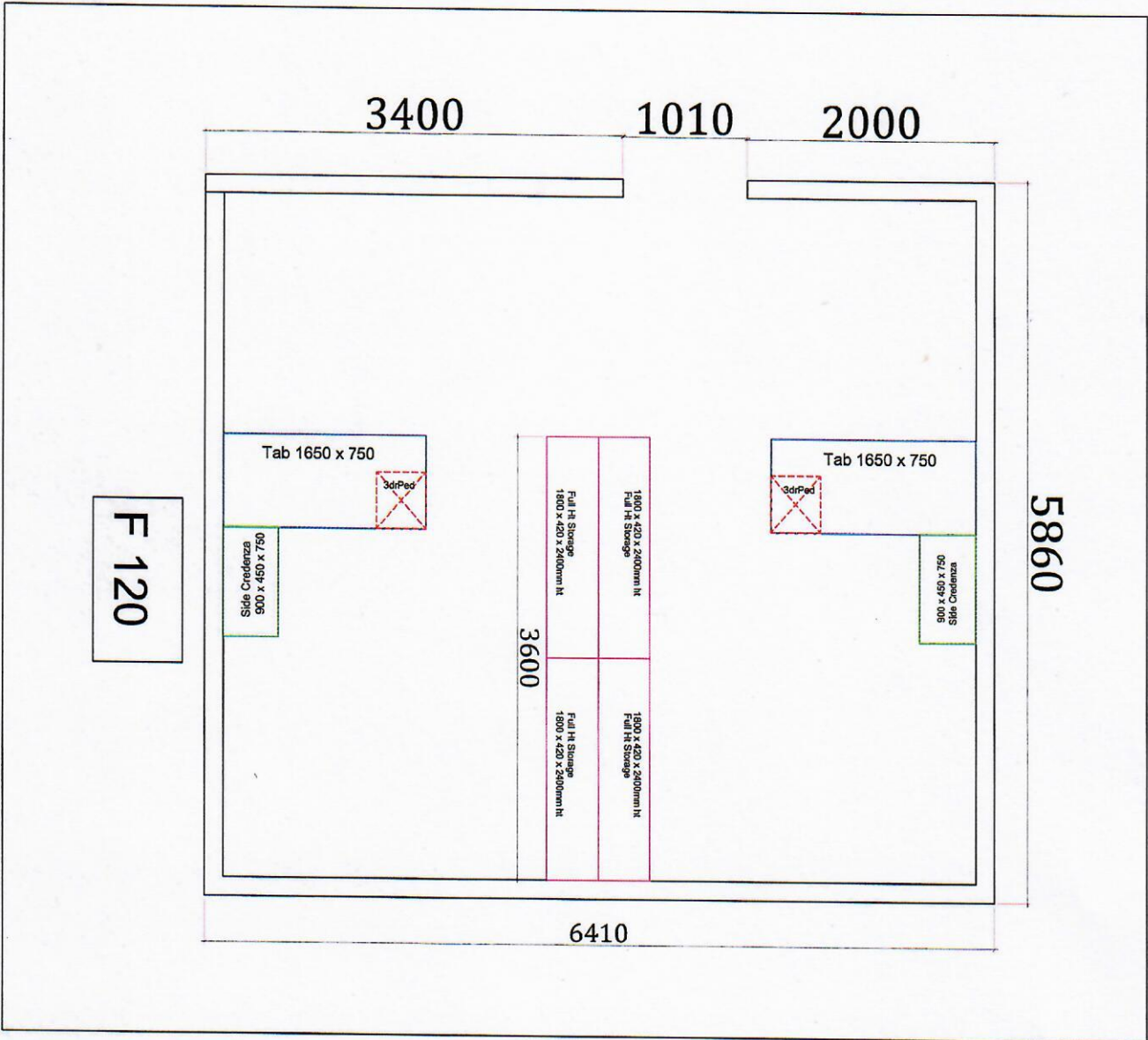

F 122

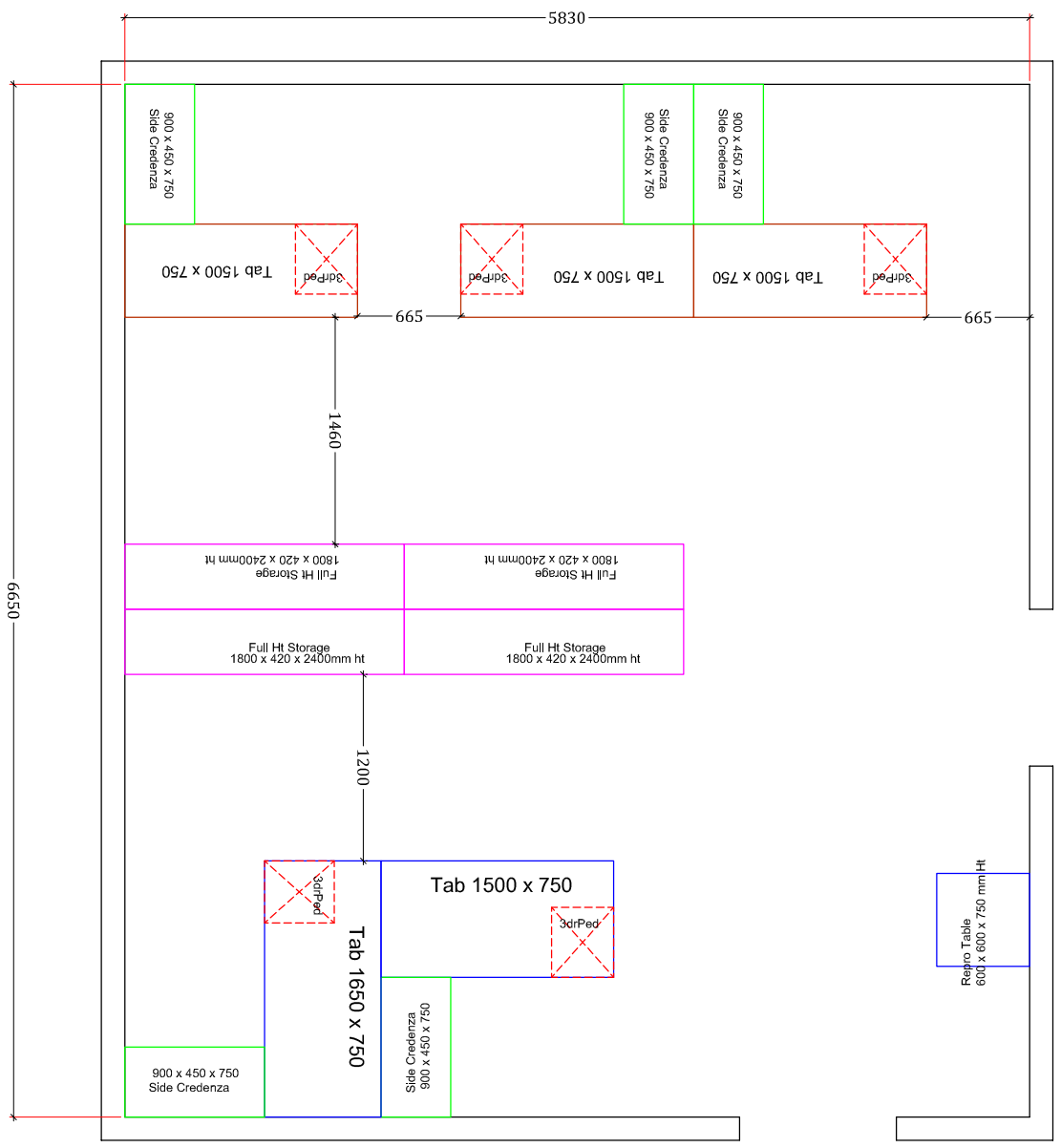

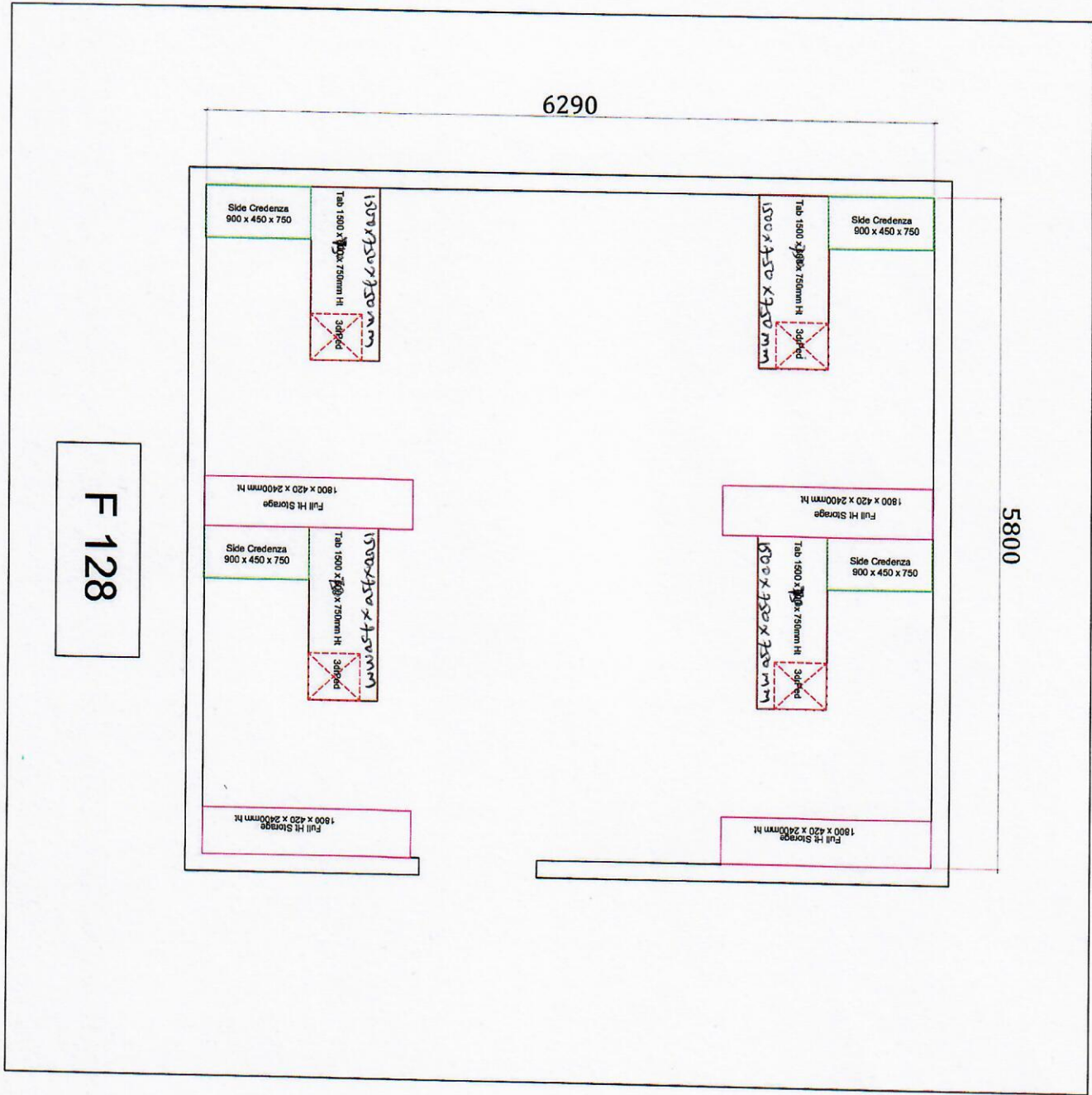

F 128

6290

5800

Side Credenza
900 x 450 x 750

Tab 1500 x 750 x 750mm ht
30" deep

Full Ht Storage
1800 x 420 x 2400mm ht

Side Credenza
900 x 450 x 750

Tab 1500 x 750 x 750mm ht
30" deep

Full Ht Storage
1800 x 420 x 2400mm ht

Tab 1500 x 750 x 750mm ht
30" deep

Side Credenza
900 x 450 x 750

Full Ht Storage
1800 x 420 x 2400mm ht

Side Credenza
900 x 450 x 750

Tab 1500 x 750 x 750mm ht
30" deep

Full Ht Storage
1800 x 420 x 2400mm ht

6320

F 132

F 130

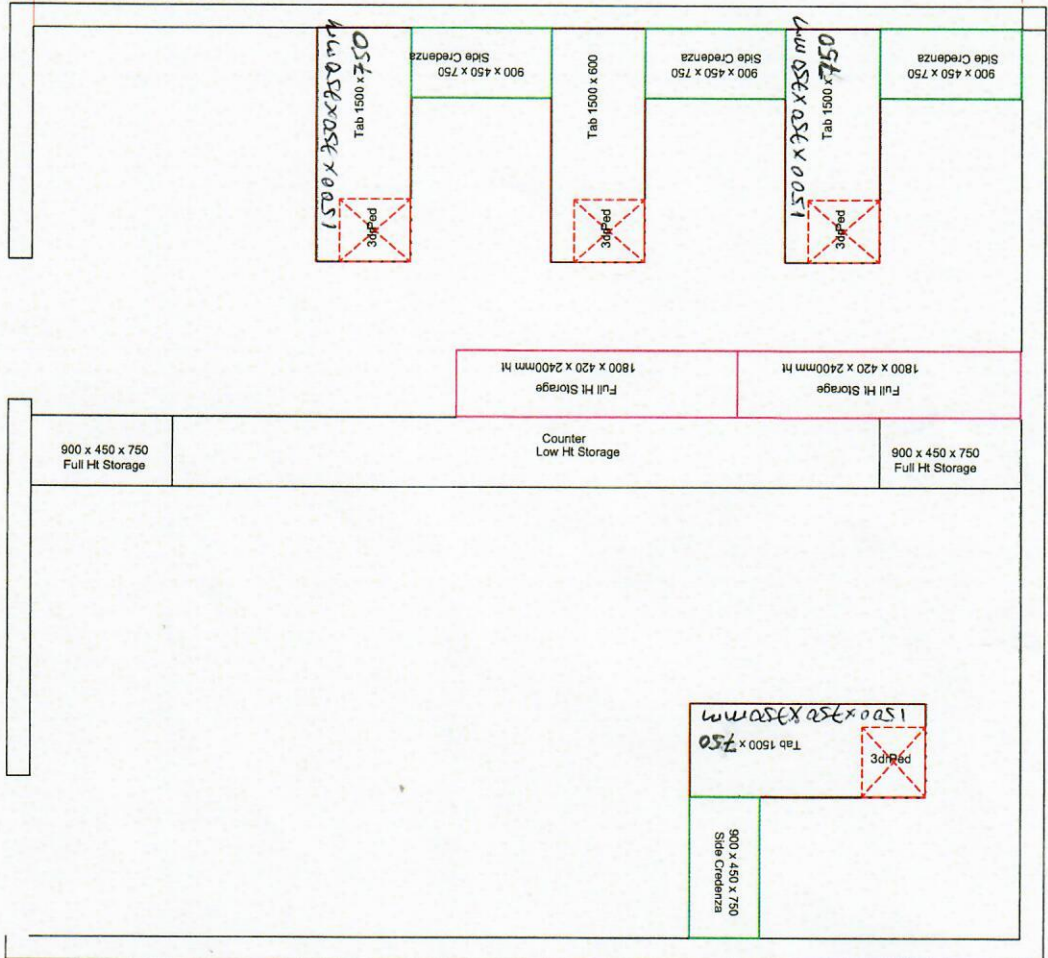

3370

5830

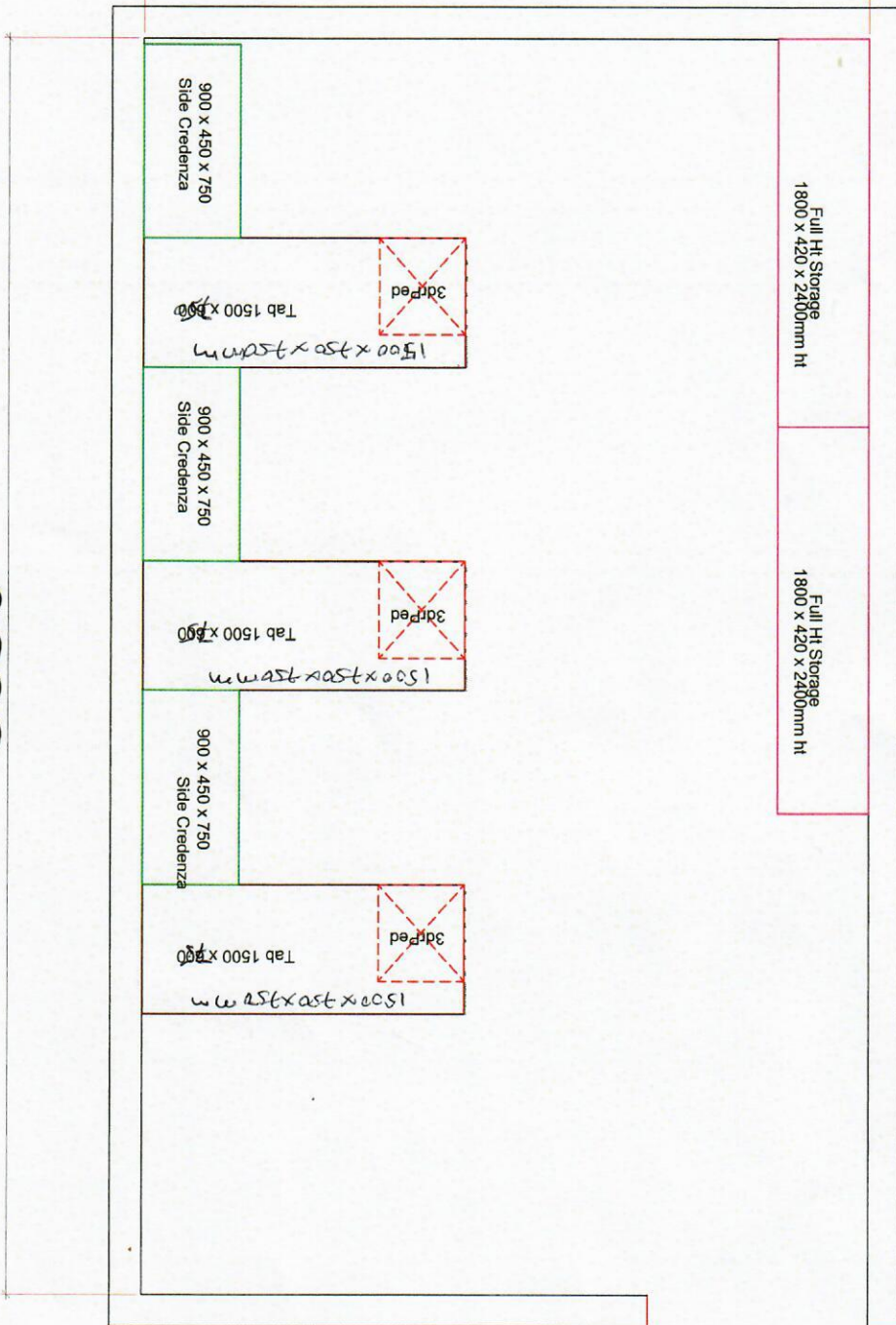

F 134

3050

5830

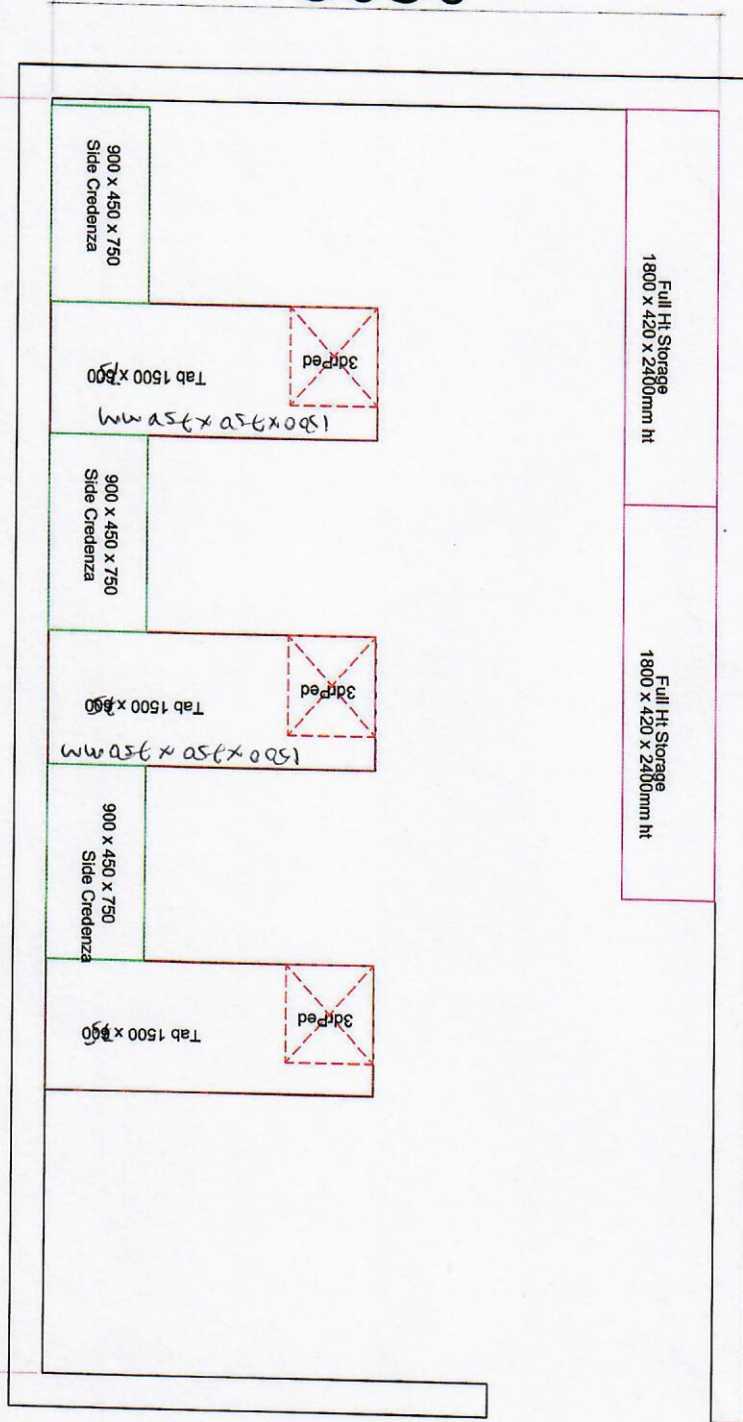

F 136

F 129

F 131

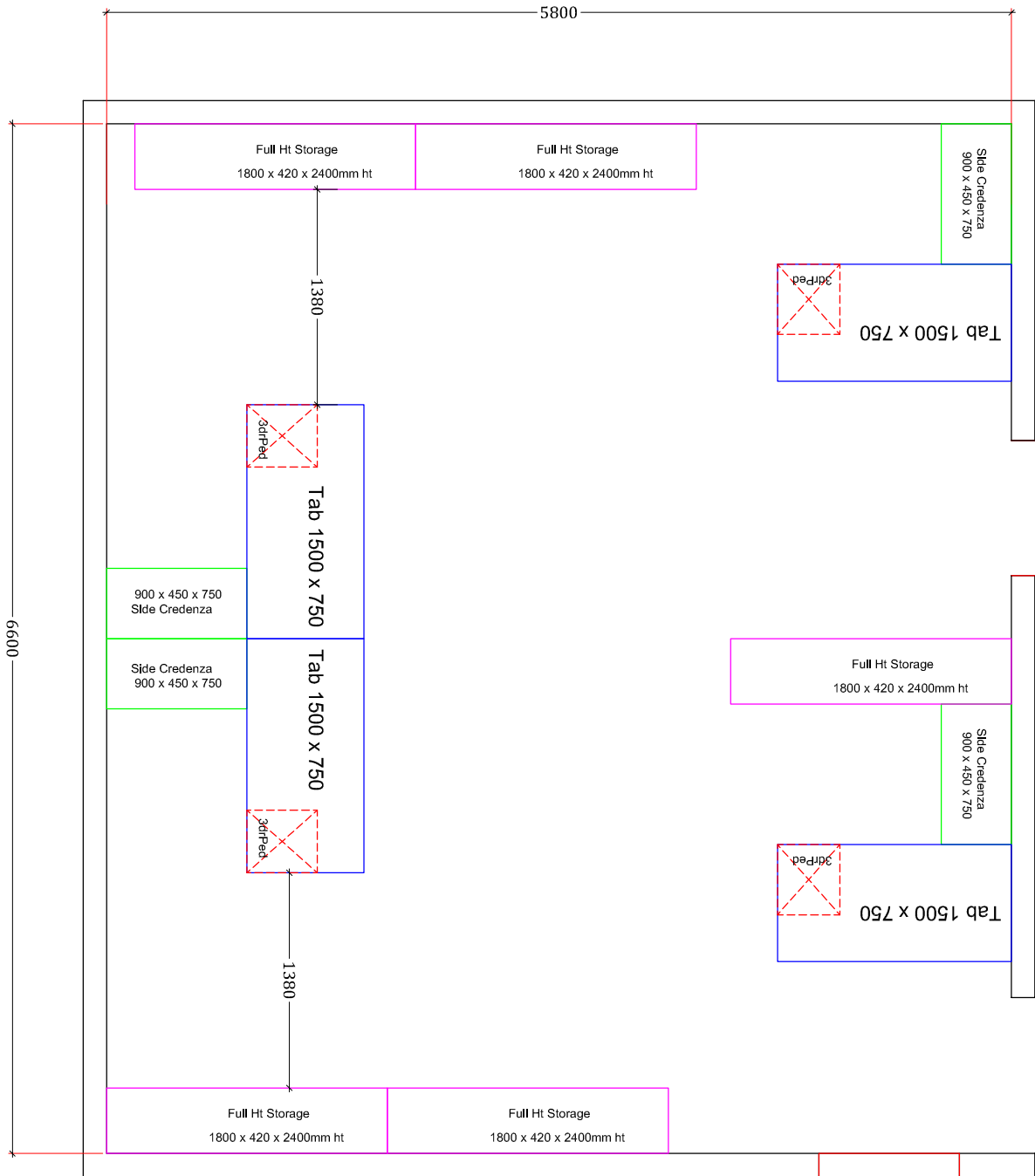

F 138

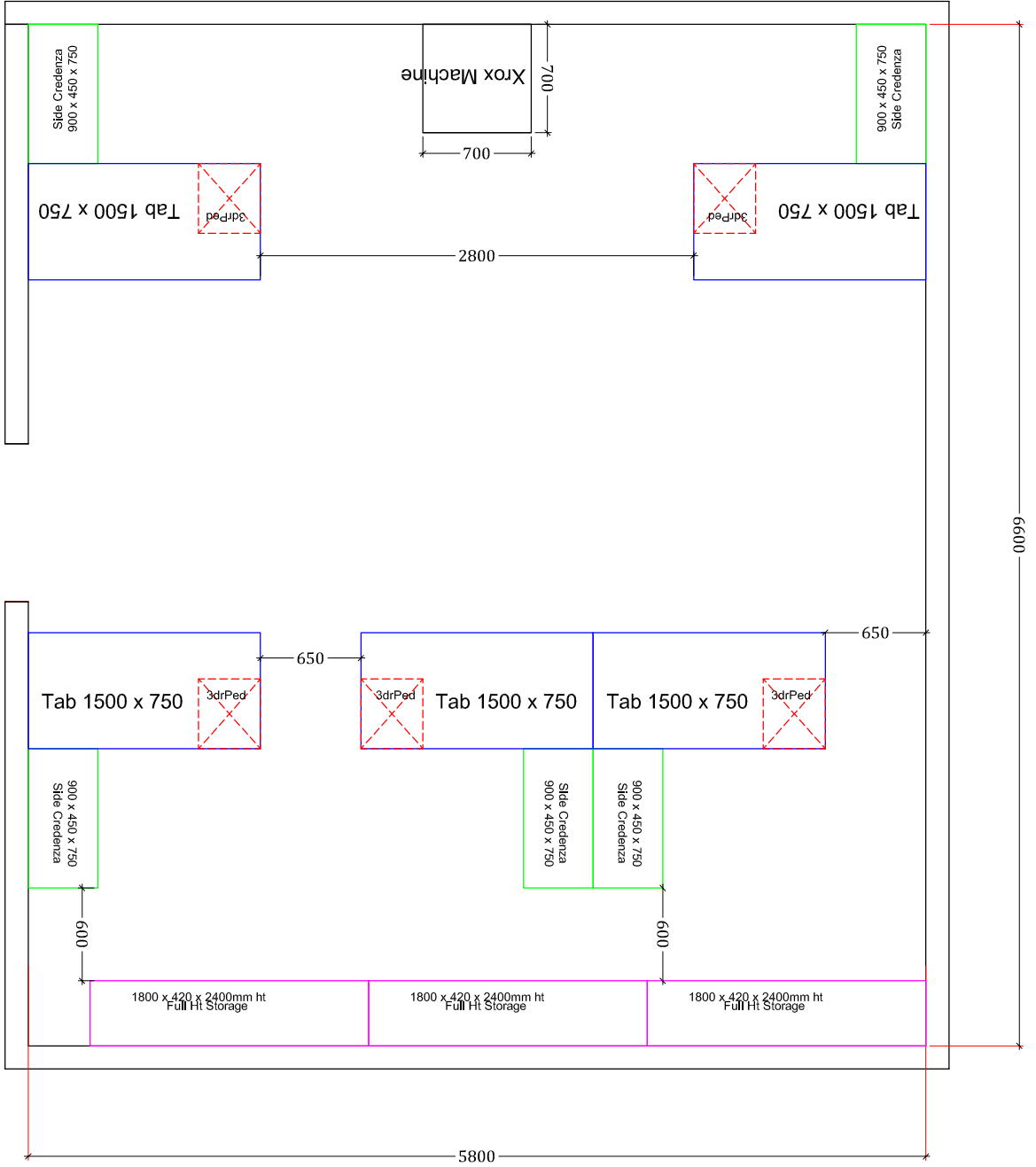

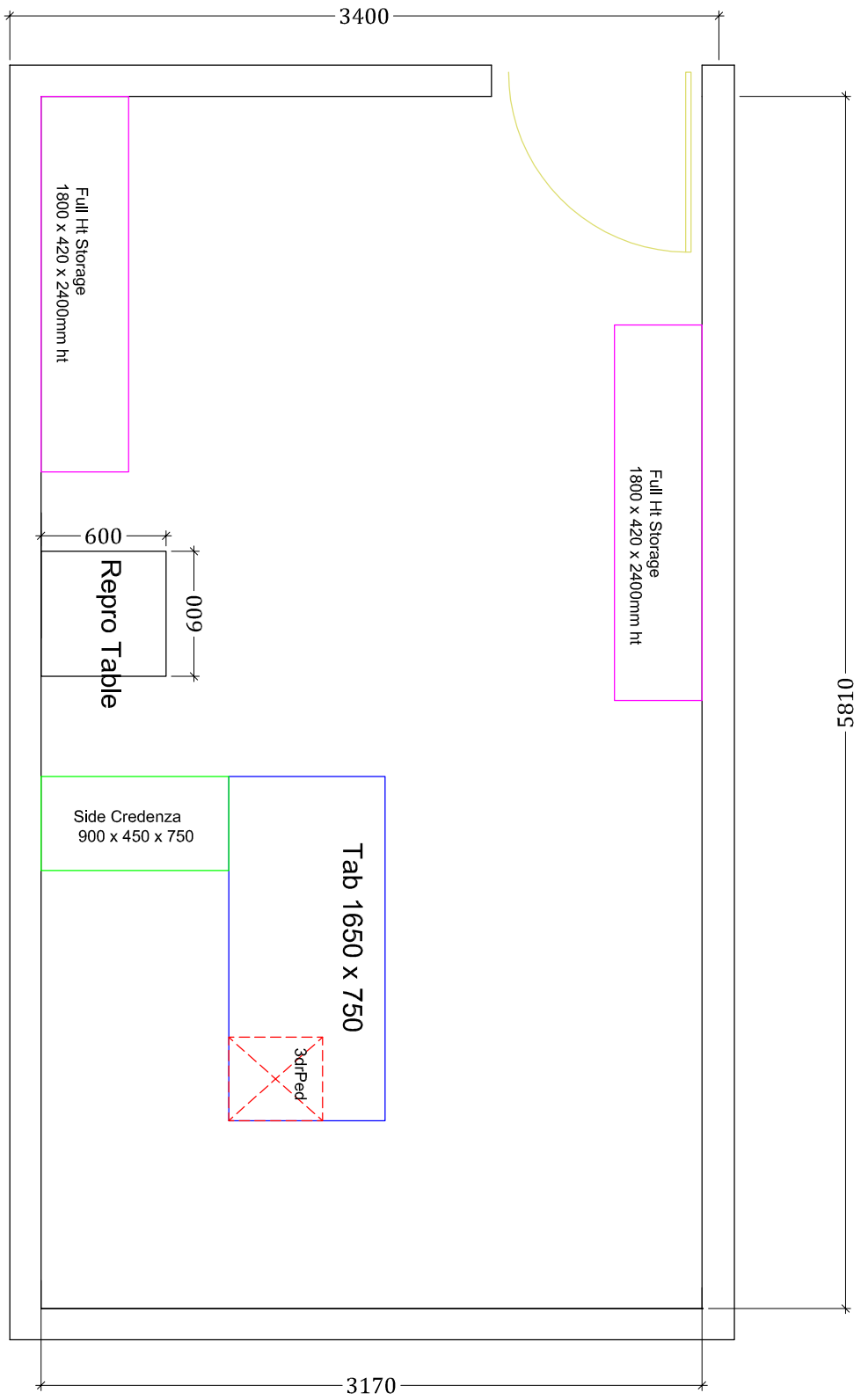

F 133

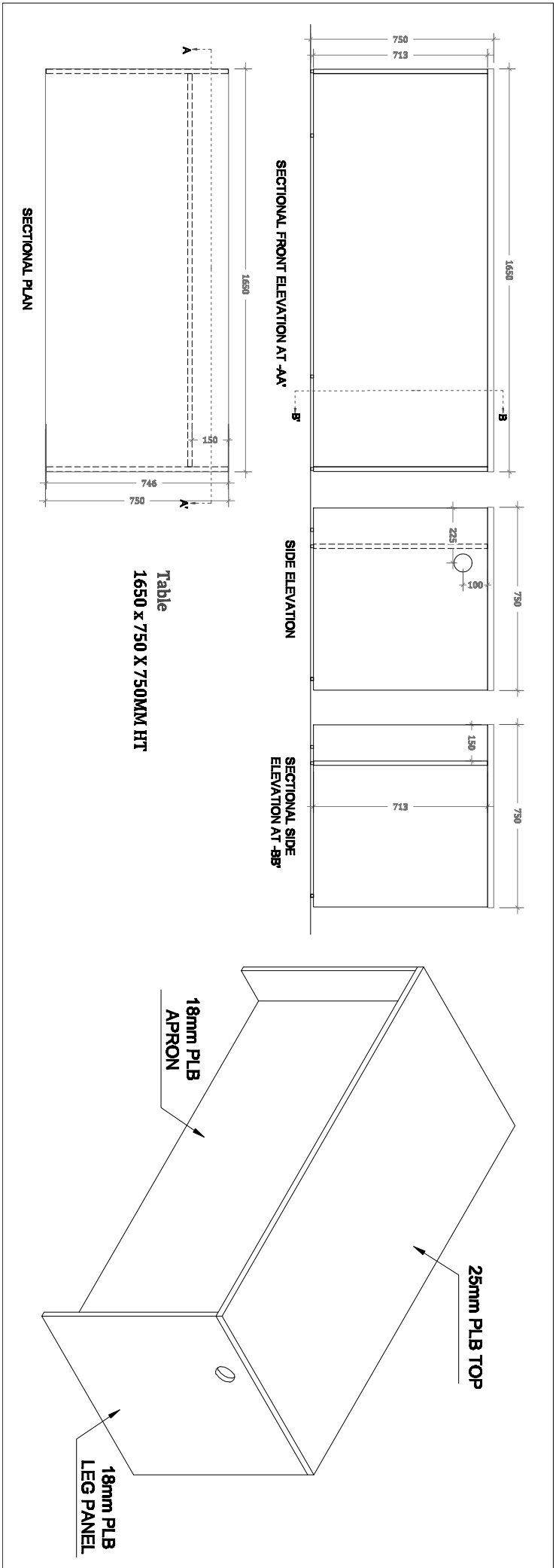

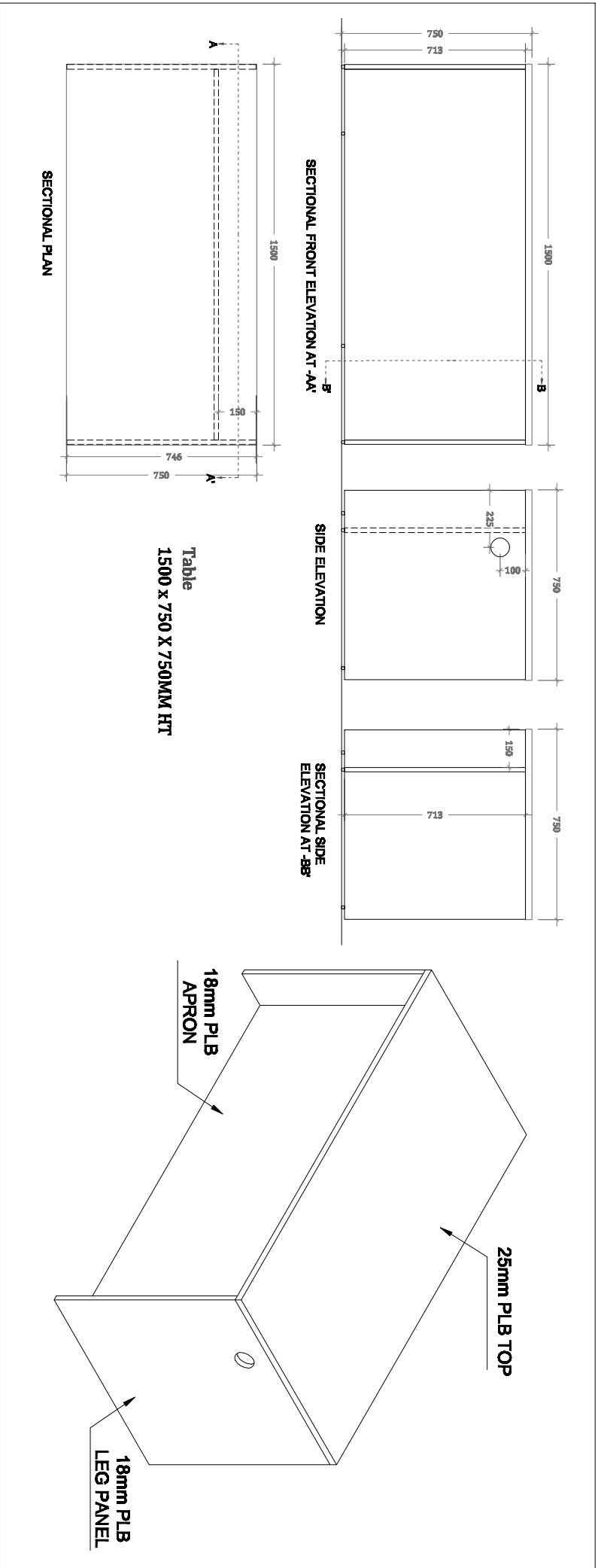

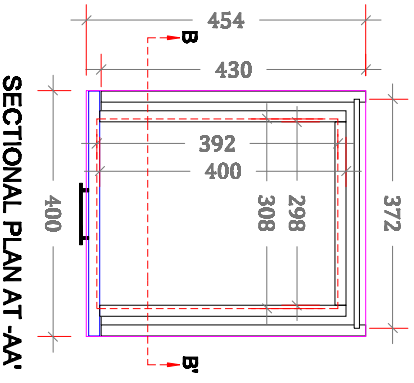
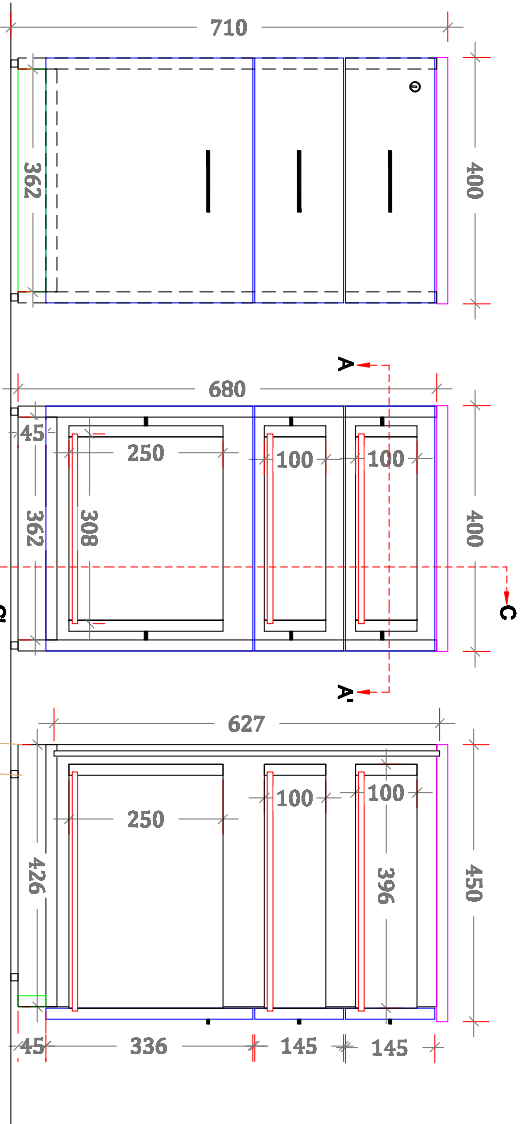

3 drawer pedestal unit
400X450X710MM HT
 Drawer side on telescopic channel
SITE-

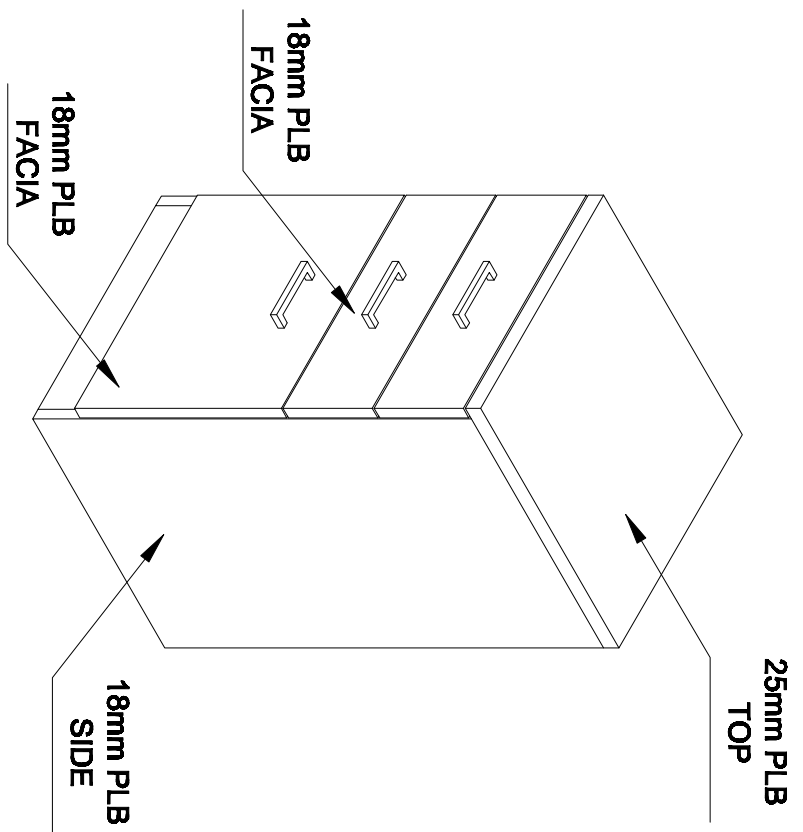

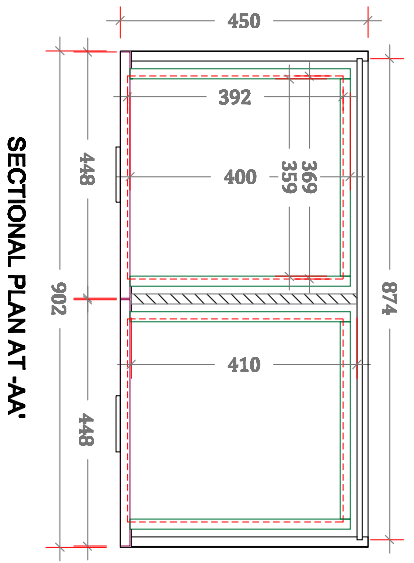
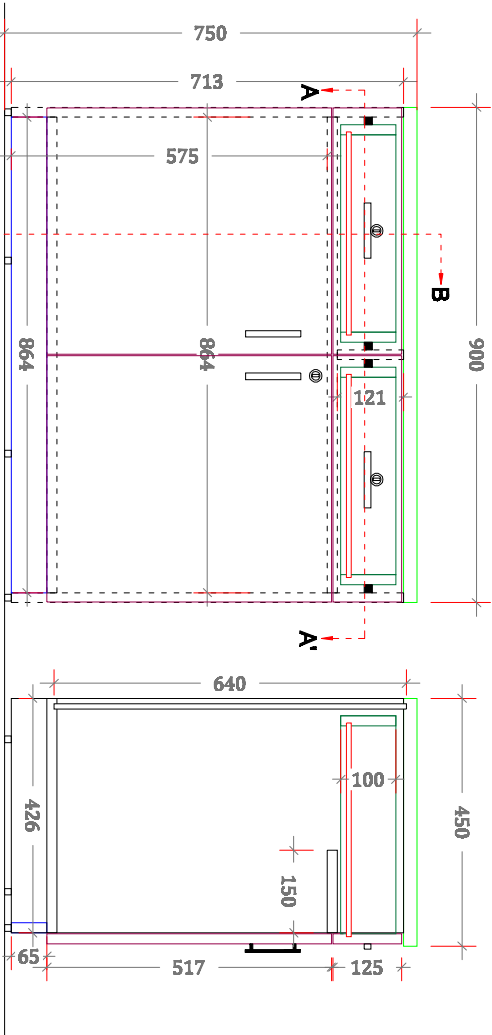

Side Credenza shutter with drawer
900X450X750MM HT
 QTY-
 SITE-

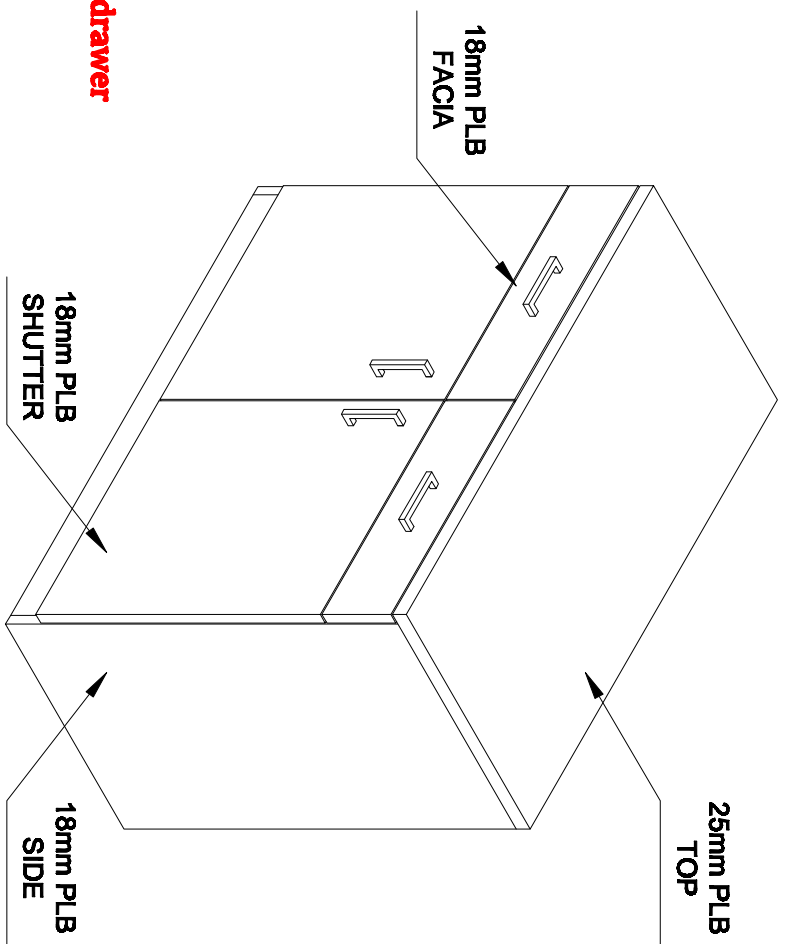

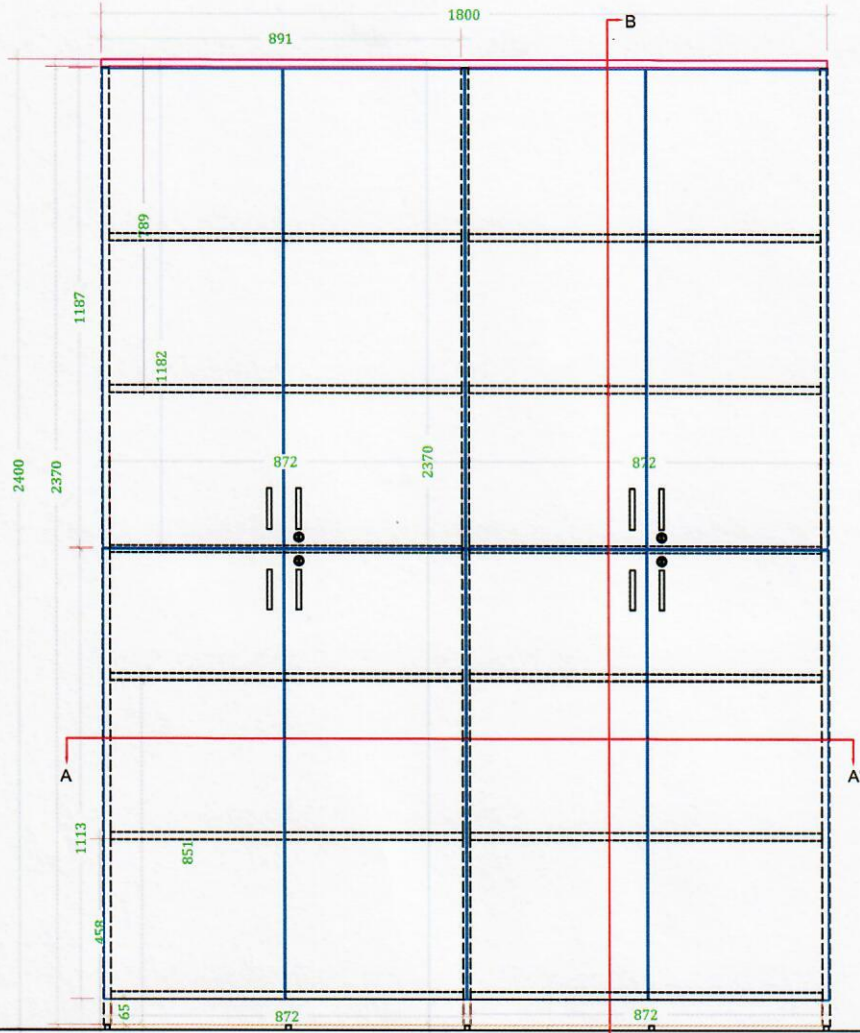

SECTIONAL FRONT ELEVATION B'-B'

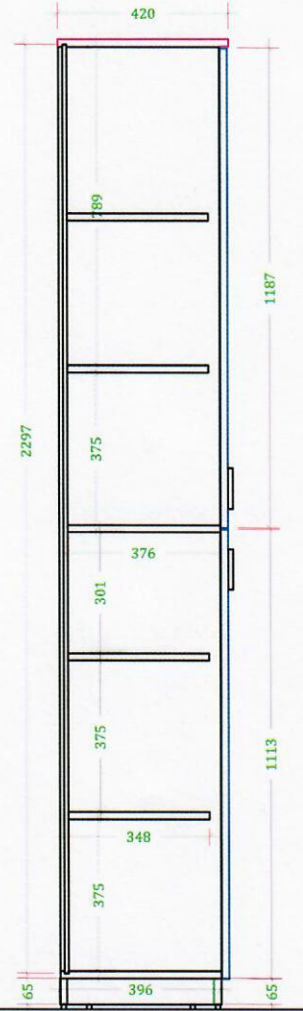

SECTIONAL SIDE ELEVATION AT -BB'

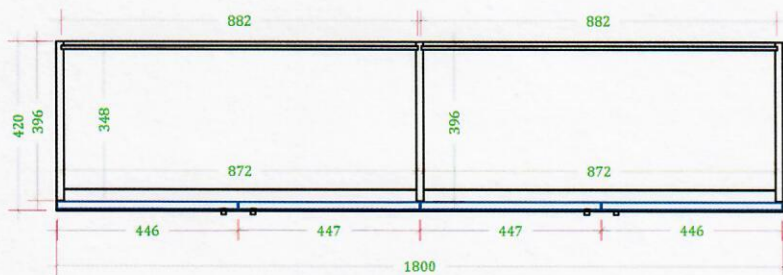

SECTIONAL PLAN AT -AA'

Full ht storage
 1800 X 420 X 2400MM HT
 QTY -
 SITE-

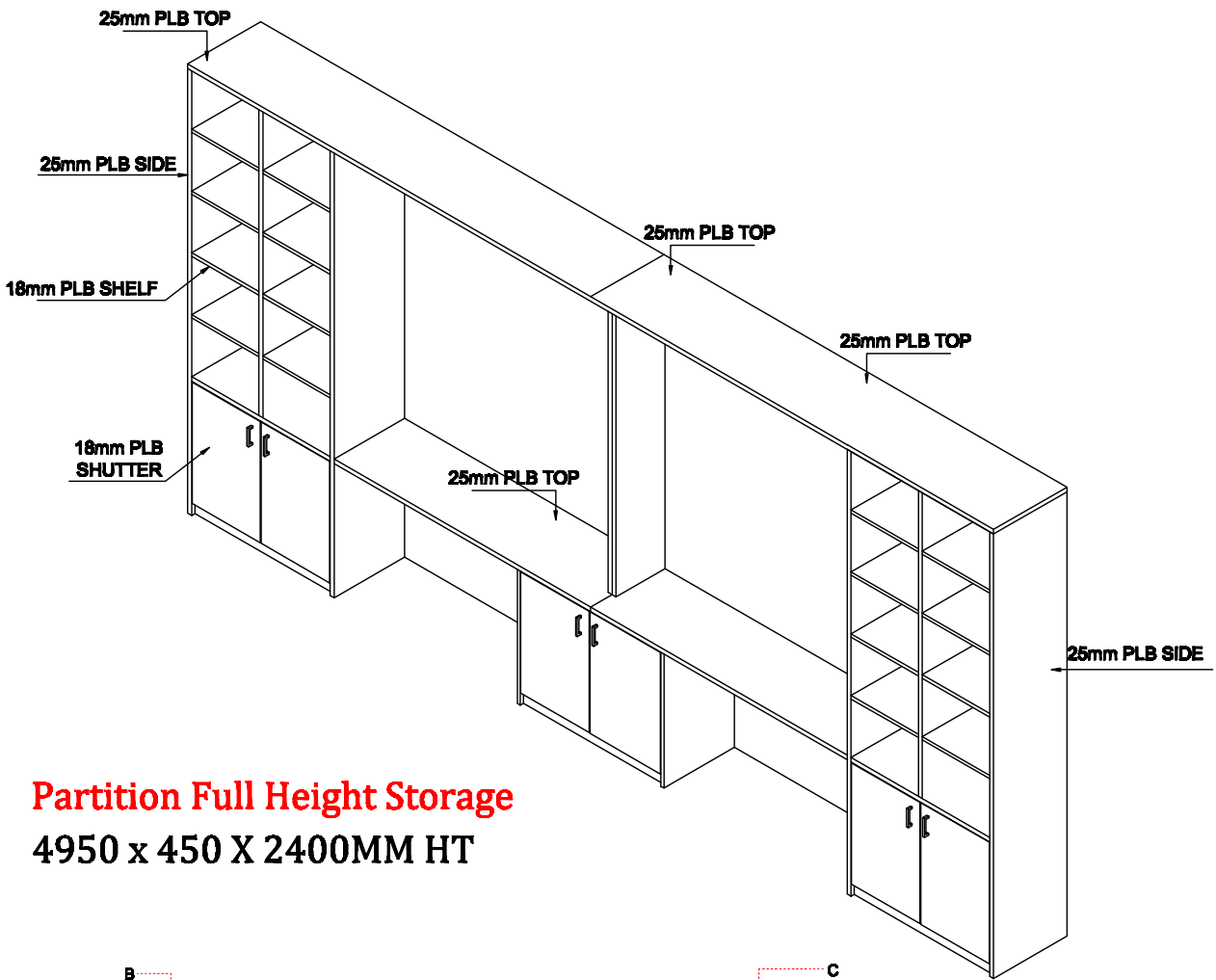

Partition Full Height Storage
4950 x 450 X 2400MM HT

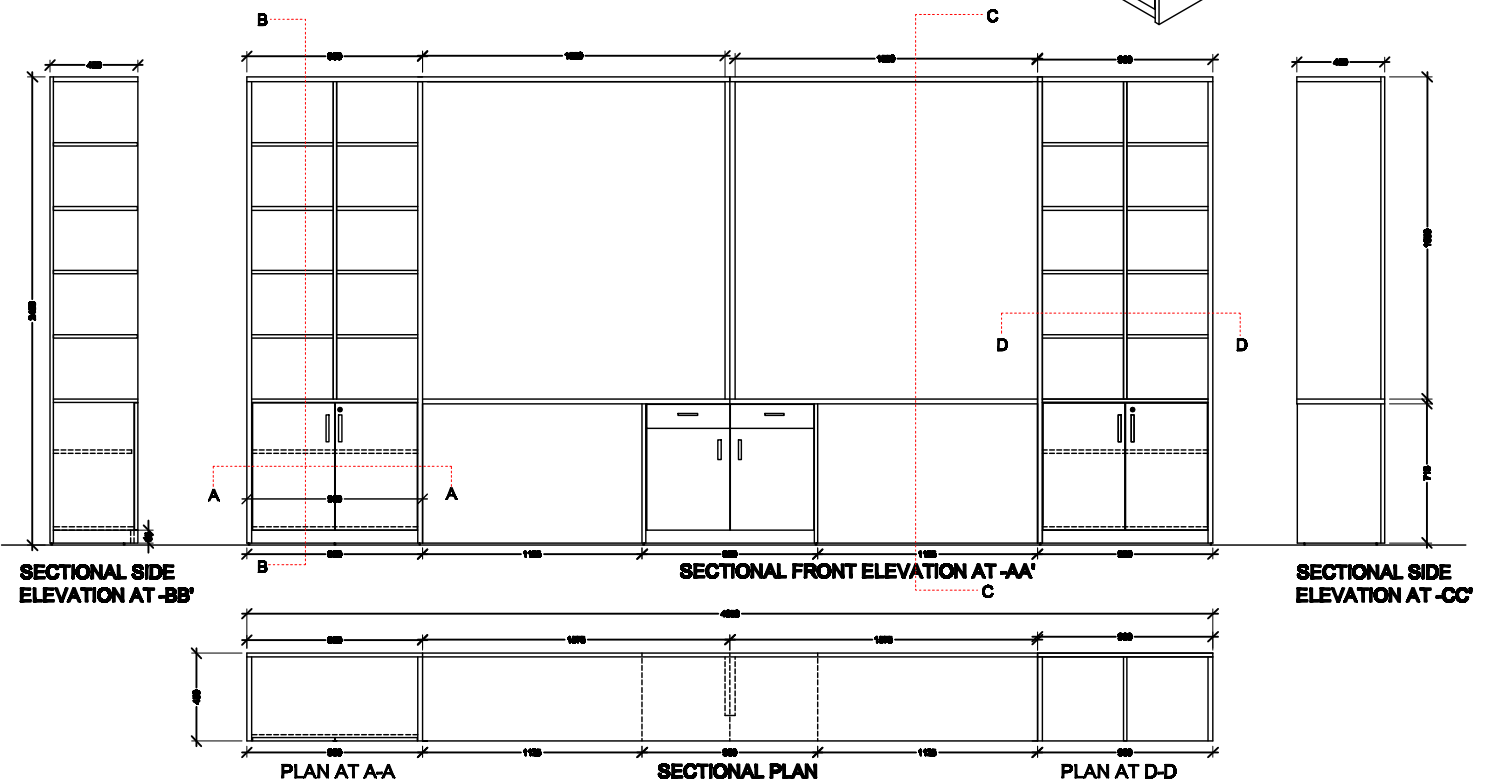

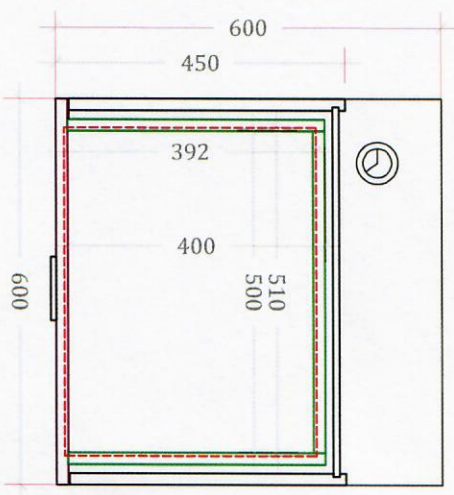
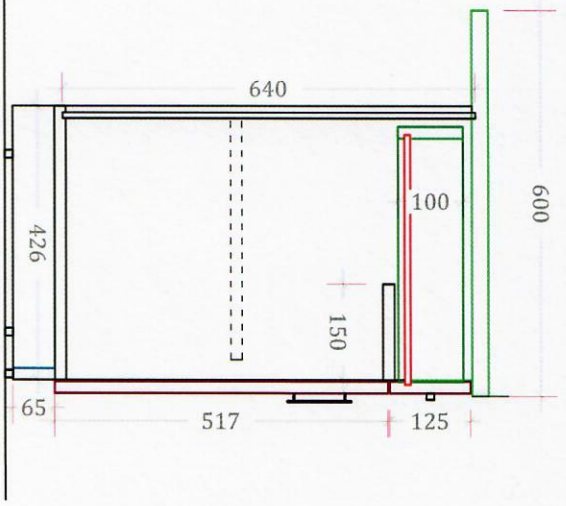
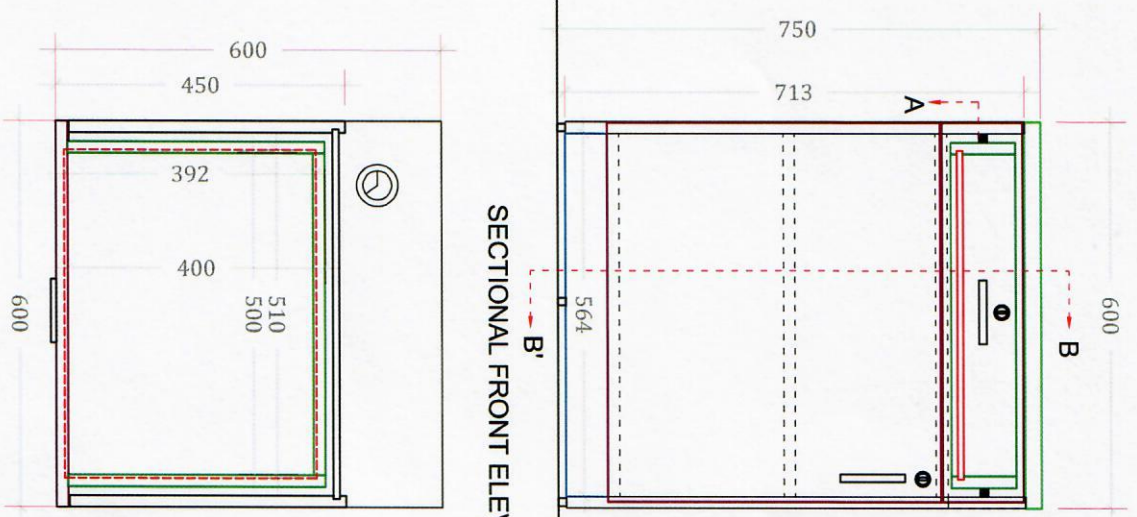

Repro Table With Storage
600 X 600 X 750MM HT
QTY-
SITE-